

Infinium HD Super Assay

Reference Guide

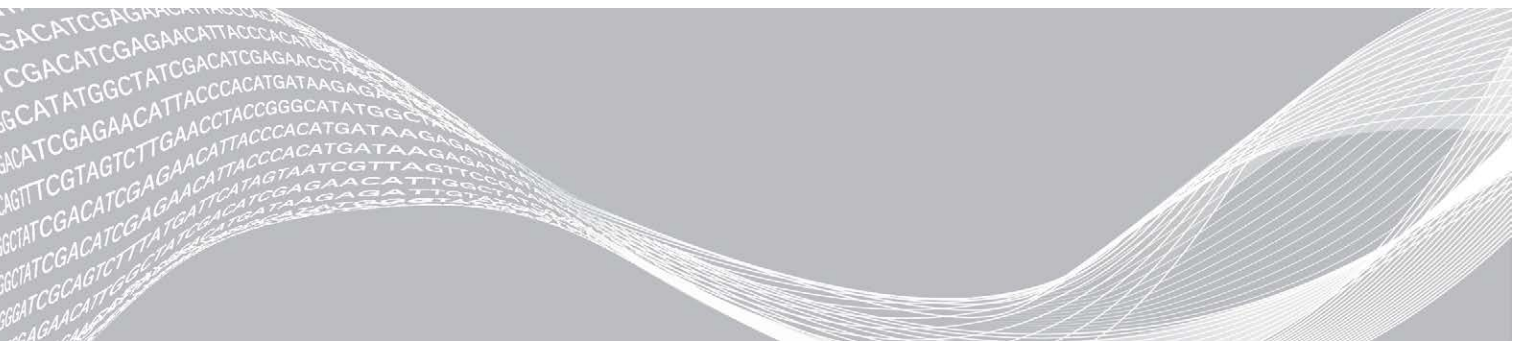

This document and its contents are proprietary to Illumina, Inc. and its affiliates ("Illumina"), and are intended solely for the contractual use of its customer in connection with the use of the product(s) described herein and for no other purpose. This document and its contents shall not be used or distributed for any other purpose and/or otherwise communicated, disclosed, or reproduced in any way whatsoever without the prior written consent of Illumina. Illumina does not convey any license under its patent, trademark, copyright, or common-law rights nor similar rights of any third parties by this document.

The instructions in this document must be strictly and explicitly followed by qualified and properly trained personnel in order to ensure the proper and safe use of the product(s) described herein. All of the contents of this document must be fully read and understood prior to using such product(s).

FAILURE TO COMPLETELY READ AND EXPLICITLY FOLLOW ALL OF THE INSTRUCTIONS CONTAINED HEREIN MAY RESULT IN DAMAGE TO THE PRODUCT(S), INJURY TO PERSONS, INCLUDING TO USERS OR OTHERS, AND DAMAGE TO OTHER PROPERTY, AND WILL VOID ANY WARRANTY APPLICABLE TO THE PRODUCT(S).

ILLUMINA DOES NOT ASSUME ANY LIABILITY ARISING OUT OF THE IMPROPER USE OF THE PRODUCT(S) DESCRIBED HEREIN (INCLUDING PARTS THEREOF OR SOFTWARE).

© 2019 Illumina, Inc. All rights reserved.

All trademarks are the property of Illumina, Inc. or their respective owners. For specific trademark information, see www.illumina.com/company/legal.html.

Revision History

Document	Date	Description of Change
Document # 11322427 v03	August 2019	Removed all references to WG# in barcode information in regards to DNA plates and MSA plates. Added Barcode Numbers section to Tips and Techniques to explain the new barcode numbering scheme.
Document # 11322427 v02	June 2019	Removed instructions for 4x1 and 4x3 BeadChips. Changed document name to <i>Infinium HD Super Assay Reference Guide</i> . Document updated to reflect latest style and formatting standards. Added Preparation and Storage of User-Supplied Reagent section to consolidate reagent preparation and use instructions. Corrected storage temperatures for MA1, PB1, RA1, XC3, and XC4. Corrected reagents listed in first and last bullets of About Reagents section in the Extend and Stain introduction. Reference to Experienced User Cards replaced with <i>Infinium HD Super Assay Checklist Manual Protocol (document # 100000080218)</i> and <i>Infinium HD Super Assay Checklist Automated Protocol (document # 100000080220)</i> which provide current format of experienced user instructions. Added list of acronyms. Consumables and equipment information moved to <i>Infinium Assay Lab Setup and Procedures Guide (document # 11322460)</i> . Added Tip and Techniques section, includes: <ul style="list-style-type: none"> • Tips, techniques, and general reagent storage and preparation information previously documented in protocol sections. • Directions to seal plates before vortex and centrifuge steps. • BeadChip handling. • Hybridization Chamber handling.
Document # 11322427 v01	November 2015	Corrected the hybridization oven temperature to 37°C when incubating the MSA1 plate and the DNA. Updated the total volume of PB1 required in relation to the number of alignment fixtures in use.

Document	Date	Description of Change
Part # 11294809 Rev. D	May 2012	Added that up to 24 BeadChips can be washed with 550 ml of PB1.
Part # 11294809 Rev. C	June 2010	Update.
Part # 11294809 Rev. B	June 2009	Update.
Part # 11294809 Rev. A	November 2008	Minor revisions.
Part # 11294809 Rev. A	May 2008	Initial release.

Table of Contents

Chapter 1 Overview	1
Introduction to Infinium HD Super Assay	1
Important Note	2
Additional Resources	2
DMAP Files	2
Preparation and Storage of User-Supplied Reagents	2
Tips and Techniques	3
Acronyms	5
Illumina LIMS	5
No Illumina LIMS	6
Tracking Tools	6
Chapter 2 Manual Protocol	7
Introduction	7
Infinium HD Super Manual Workflow	7
Amplify DNA	9
Incubate DNA	10
Fragment DNA	10
Precipitate DNA	11
Resuspend DNA	13
Hybridize to BeadChip	14
Wash BeadChips	19
Extend and Stain BeadChips	25
Image BeadChip	34
Illumina GenomeStudio	35
Chapter 3 Automated Protocol	37
Introduction	37
Infinium HD Super Automated Workflow	37
Amplify DNA	39
Incubate DNA	41
Fragment DNA	41
Precipitate DNA	42
Resuspend DNA	44
Hybridize to BeadChip	46
Wash BeadChips	53
Extend and Stain BeadChips	58
Image BeadChip	68
Illumina GenomeStudio	69
Technical Assistance	70

Overview

Introduction to Infinium HD Super Assay	1
Important Note	2
Additional Resources	2
DMAP Files	2
Preparation and Storage of User-Supplied Reagents	2
Tips and Techniques	3
Acronyms	5
Illumina LIMS	5
No Illumina LIMS	6
Tracking Tools	6

Introduction to Infinium HD Super Assay

The Illumina Infinium HD Super Assay is an evolution for DNA analysis, by streamlining sample preparation and enabling high multiplexing. Using Infinium I and Infinium II probe designs and a dual-color channel approach, the Infinium HD Super Assay enables the DNA analysis of up to several million of SNPs and CNV markers per sample.

The Infinium HD Super Assay accomplishes this unlimited multiplexing by combining whole-genome amplification (WGA) sample preparation with direct, array-based capture, and enzymatic scoring of the SNP loci. Locus discrimination or copy number variation (CNV) determination comes from a combination of high bead type representation per feature, sequence-specific hybridization capture and array-based, single-base primer extension. In the case of the Infinium II probe design, the 3' end of the primer is positioned directly adjacent to the SNP site, or if a nonpolymorphic probe, directly adjacent to the nonpolymorphic site. With the Infinium I probe design, the 3' end of the primer overlaps with the SNP site. If there is a perfect match, extension occurs and signal is generated. If there is a mismatch, extension does not occur and no signal is generated.

Allele-specific single base extension of the primer incorporates a biotin nucleotide or a dinitrophenyl labeled nucleotide. C and G nucleotides are biotin labeled; A and T nucleotides are dinitrophenyl labeled. Signal amplification of the incorporated label further improves the overall signal-to-noise ratio of the assay.

The Infinium HD Super Assay offers:

- ▶ High multiplexing
- ▶ High call rate and accuracy
- ▶ Unlimited genomewide marker selection
- ▶ Single tube amplification, single chip, no PCR
- ▶ Minimal risk of carryover contamination
- ▶ Low DNA input—200 ng per sample
- ▶ Walk-away automation using Tecan Genesis or Freedom EVO Robots and Tecan GenePaint system
- ▶ Compatibility with Illumina iScan and HiScan System
- ▶ Multiple-sample BeadChip format

Important Note

Before using the procedures in this guide, read the *Infinium Lab Setup and Procedures Guide*. The *Setup and Procedures* guide explains how to equip and run an Infinium HD Super Assay laboratory, including information on the following topics:

- ▶ Prevention of amplification product contamination
- ▶ Safety precautions
- ▶ Consumables and equipment to purchase in advance
- ▶ Standard lab procedures
- ▶ Robot use for automation
- ▶ Preparation for BeadChip imaging
- ▶ System Controls
- ▶ System maintenance
- ▶ Troubleshooting

The instructions apply equally to all Infinium BeadChips provided by Illumina™. All Infinium HD Super documentation assumes that you have already set up the laboratory space and that you are familiar with the standard procedures and safety precautions.

Additional Resources

Visit the Infinium HD Super Assay support page on the Illumina website for documentation, software downloads, training resources, and information about compatible Illumina products.

The following documentation is available for download from the Illumina website.

Resource	Description
<i>Infinium HD Super Assay Checklist Automated Protocol (document # 1000000080220)</i>	Provides a checklist for experienced users of the Infinium HD Super Assay when performing the automated protocol.
<i>Infinium HD Super Assay Checklist Manual Protocol (document # 1000000080218)</i>	Provides a checklist for experienced users of the Infinium HD Super Assay when performing the manual protocol.
<i>Infinium Lab Setup and Procedures Guide (document #11322460)</i>	Describes how to set up an Infinium HD Super lab including reagents, consumables, and equipment to purchase in advance, and best practices for lab operation.
<i>Infinium Consumables and Equipment List (document # 1000000084294)</i>	Provides an interactive checklist of Illumina-provided and user-provided consumables and equipment.

DMAP Files

Before run setup, download the DMAP files for the arrays, and prepare a sample sheet. Use the Decode File Client to download the DMAP files.

Preparation and Storage of User-Supplied Reagents

- ▶ Maintain a first in, first out (FIFO) system for reagents. Rotate the stock of the remaining reagents to avoid using expired reagents.
- ▶ Infinium HD Super kits contain reagents in exact quantities needed for the assay. Measure reagents carefully to avoid shortages.

- ▶ Use fresh reagents for each batch of plates, and empty reservoirs between batches.
- ▶ To minimize errors when preparing user-supplied reagents, prepare large batches of 0.1 N NaOH and 95% Formamide/1 mM EDTA using the following guidance.

Preparing Batches of 0.1 N NaOH

Prepare fresh 0.1 N NaOH in large batches. Divide batches into 15 ml or 50 ml sealed tubes.

Store the sealed tubes for 6 months at 2°C to 8°C and use the stored 0.1 N NaOH as needed. Use the 0.1 N NaOH the same day you open the tube, and discard any unused amounts.

Preparing Batches of 95% Formamide/1 mM EDTA

Prepare the 95% formamide/1 mM EDTA mixture in large batches. Divide batches into 15 ml or 50 ml sealed tubes.

Store the sealed tubes for up to 6 months at -25°C to -15°C and use the stored mixture as needed. Use the mixture the same day you open the tube, and discard any unused amounts.

Use Fresh RA1 Reagent for Each Step

Use fresh RA1 for each step in the assay where it is required. RA1 that has been stored properly and has not been dispensed for use in either the XStain or Resuspension step is considered fresh RA1. After RA1 has been exposed to room temperature air for extended periods of time, it is no longer fresh.

To make best use of RA1, only pour the amount needed for the current step. If you plan to perform additional assay steps requiring RA1 the same day, leave the remaining thawed reagent in the original, closed bottle at room temperature until it is needed. Follow the standard RA1 storage procedures described in this guide for next-day processing and prolonged storage conditions.

Store PB1

For Infinium HD Super workflows do the following.

- ▶ Store PB1 at room temperature.
- ▶ Keep PB1 for up to 3 months.

Tips and Techniques

Unless a safe stopping point is specified, proceed immediately to the next step.

Avoid Cross-Contamination

When adding or transferring samples, change tips between *each sample*.

Measure Volumes Carefully

When measuring volumes of reagent to put in reservoirs, make sure that the measurements are exactly as specified in the instructions. Do not estimate volumes.

HD Glass Back Plates

- ▶ For optimal performance, use HD glass back plates that are free of chips and cracks along the beveled edge and the long edges. Chipped or cracked HD glass back plates risk volume leakage and affect overall performance.

- ▶ Clean HD glass back plates according to the procedures in the *Infinium Assay Lab Setup and Procedures Guide (Document # 11322460)*.
- ▶ A 10% bleach soak is required weekly, or every seven uses, to maintain glass performance.

Barcode Numbers

- ▶ Barcode serial numbers used for workflow enforcement and positive sample tracking on MSA plates, DNA plates, and reagents use a numbering pattern of two alphanumeric characters followed by seven random numbers.

Sealing the Plate

- ▶ Always seal plates before the vortex and centrifuge steps in the protocol.
- ▶ Orient sealing mats so that the A1 on a cap matches the A1 on the plate.
 - ▶ Make sure that all 96 caps are securely seated in the wells to prevent evaporation and spills, which introduce variability and cross-contamination.
 - ▶ Remove sealing mats slowly and carefully to prevent splashing, and then set aside upside-down in a safe location.
 - ▶ When returning a sealing mat to a plate, make sure that the orientation is correct.

Heat Sealer

- ▶ If you are using the ALPS 50 V model heat sealer, set it to 165°C and 2.5 seconds.

Pipetting

- ▶ Make sure that pipettes are properly calibrated, cleaned, and decontaminated.
- ▶ Dispense slowly and carefully to prevent turbulence in the plate wells and flow-through chambers.
- ▶ Use a multichannel pipette whenever possible.

Centrifugation

- ▶ When centrifuging plates or BeadChips, place a balance plate or rack with BeadChips opposite each plate or rack being centrifuged. Make sure that the weights are as similar as possible.

Washing and Coating BeadChips

Perform the following steps before starting the wash and coat process:

- ▶ Place wash dish covers on wash dishes when not in use.
- ▶ Clean wash dishes with low-pressure air to remove particulates before use.
- ▶ Wash tube racks and wash dishes thoroughly before and after use. Rinse with DI H₂O. Place them upside down on wash rack to dry.
- ▶ Prepare an additional clean tube rack that fits the internal dimensions of the vacuum desiccator. Allow one rack per eight BeadChips.

Handling Hybridization Chambers

- ▶ Keep the chamber lids and bases together. Adopt a labeling convention that pairs each chamber base with the original lid.

- ▶ Regularly check lid-base pairs to make sure that they fit securely. Also check hinges for signs of abnormal wear or loose fittings. An airtight seal requires that the hinges have adequate clamping strength.
- ▶ Record which hybridization chamber was used for each BeadChip. If sample evaporation or other processing anomalies occur, investigate the appropriate hybridization chambers.
- ▶ When the hybridization chamber inserts contain BeadChips, keep them steady and level when lifting or moving.
 - ▶ Avoid shaking, and always keep parallel to the lab bench.
 - ▶ Do not hold by the sides near the sample inlets.

Rocker Platform [Optional]

If you are using an Illumina Hybridization Oven with a rocker platform, follow these guidelines:

- ▶ If 7 to 12 hybridization chambers (Hyb Chambers) are placed in 1 hybridization oven, the rocker must be removed before beginning the *Hybridize to BeadChip* section.
- ▶ If 1 to 6 Hyb Chambers are placed in 1 hybridization oven, removing the rocker platform before beginning the *Hybridize to BeadChip* section is optional.
- ▶ Removing the rocker platform is optional for plate incubation in the *Amplify DNA*, *Incubate DNA*, *Fragment DNA*, *Precipitate DNA*, and *Resuspend DNA* sections.

Acronyms

Acronym	Definition
EDTA	Ethylenediaminetetraacetic acid
EtOH	Ethanol
ATM	Anti-Stain Two-Color Master Mix
FMS	Fragmentation solution
MA1	Multi-Sample Amplification 1 Mix
MA2	Multi-Sample Amplification 2 Mix
MSM	Multi-Sample Amplification Master Mix
PB1	Reagent used to prepare BeadChips for hybridization
PB2	Humidifying buffer used during hybridization
PM1	Precipitation solution
RA1	Resuspension, hybridization, and wash solution
STM	Superior Two-Color Master Mix
TEM	Two-Color Extension Master Mix
XC1	XStain BeadChip solution 1
XC2	XStain BeadChip solution 2
XC3	XStain BeadChip solution 3
XC4	XStain BeadChip solution 4

Illumina LIMS

If you are using the automated protocol with Illumina LIMS, follow these guidelines:

- ▶ At each step in the protocol, make sure that the **Use Barcodes** checkbox is selected.

- ▶ The barcode must be on the right side of the plate. Make sure the barcode label fits between the notches and does not cover the holes on the top of the plate.

Figure 1 Correctly Placed Barcodes

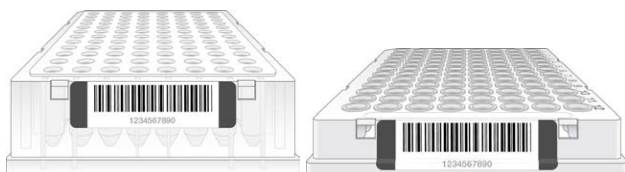

- ▶ When prompted, enter the number of samples, plates, or BeadChips, and then select **OK**.
- ▶ Each time you select **Run** to start a new process, you are prompted to log in to LIMS.
- ▶ If prompted to select the project and the batch ID or DNA plate, do one of the following:
 - ▶ Select your current project. The available batches appear in the Sample Batch ID pane. Select a batch to see the associated DNA plate appear in the DNA Plates pane.
 - ▶ Use **Search** to search for a specific Batch ID or DNA plate.
- ▶ Some protocol steps require verification in the LIMS HTML user interface before you can begin processing on the robot.
 - ▶ If verification is successful, a blue confirmation message appears at the top of the window.
 - ▶ If the verification fails, a red error message appears at the top of the window. Do **not** proceed. Instead, follow these steps to troubleshoot the problem:
 - Select the Reports tab in the upper-right corner.
 - In the left pane, select **Tracking Reports | Get Queue Status**.
 - Scan the plate barcode, and select **Go**.
 - Note which step the plate is queued to run, and proceed with that step.
 - If the error message indicates the BeadChip did not accession into the system, accession it and repeat the verification step.
 - If the BeadChip is not the right type for the batch, accession the correct type and repeat the verification step.

No Illumina LIMS

If you are using the automated protocol without Illumina LIMS do the following:

- ▶ At each step in the protocol, make sure that the **Use Barcodes** checkbox is cleared.
- ▶ At each step in the protocol, you are prompted to enter the number of samples, plates, or BeadChips. Enter the requested information, and then select **OK**.

Tracking Tools

Illumina provides the following tools for sample tracking and guidance in the lab:

- ▶ **Checklists** to guide you through the protocols. There is a checklist for each protocol, manual and automated.
- ▶ **Lab Tracking Form** to map DNA samples to BeadChips and record the barcode of each reagent and plate used in the protocol. Record operator information, and start and stop times.
- ▶ **Sample sheet template** to record information about your samples for later use in data analysis.

These documents are available for printing and reference at www.illumina.com/documentation.

Chapter 2 Manual Protocol

Introduction	7
Infinium HD Super Manual Workflow	7
Amplify DNA	9
Incubate DNA	10
Fragment DNA	10
Precipitate DNA	11
Resuspend DNA	13
Hybridize to BeadChip	14
Wash BeadChips	19
Extend and Stain BeadChips	25
Image BeadChip	34
Illumina GenomeStudio	35

Introduction

This section describes pre- and post-amplification manual laboratory protocols for the Infinium HD Super Assay. Follow the protocols in the order shown.

Infinium HD Super Manual Workflow

The following figure graphically represents the Infinium HD Super Assay manual workflow for 24 BeadChips. These protocols describe the procedure for preparing 96 DNA samples.

Figure 2 Infinium HD Super Manual Workflow

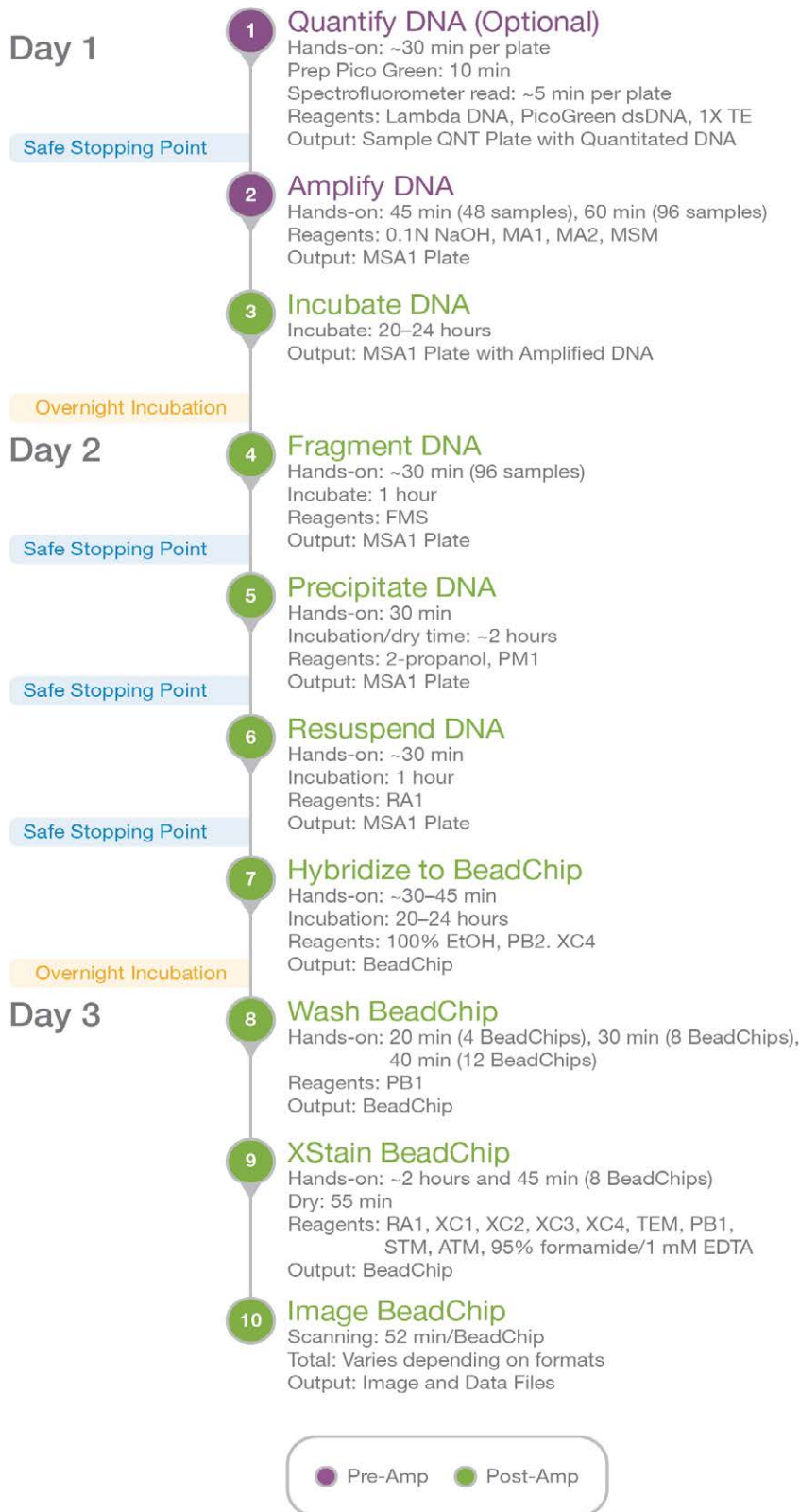

Amplify DNA

This step adds the DNA samples to the plates. The samples are denatured and neutralized to prepare them for amplification.

Consumables

- ▶ MA1 (2 tubes)
- ▶ MA2 (2 tubes)
- ▶ MSM (2 tubes)
- ▶ 0.1N NaOH (15 ml)
- ▶ 96-well 0.8 ml microplate (midi) (1 plate)
- ▶ DNA plate with 48 or 96 DNA samples (50 ng/μl) (midi or TCY) (1 plate)
- ▶ Cap mats

Preparation

- 1 Preheat the Illumina Hybridization Oven in the post-amp area to 37°C and allow the temperature to equilibrate.
- 2 Prepare the following consumables:

Item	Storage	Instructions
DNA	-25°C to -15°C	Thaw at room temperature. DNA must be 50 ng/μl, resuspended in TE (10 mM Tris, 1mM EDTA).
MA1	Room temperature	Thaw at room temperature. Invert 10 times to mix, and then pulse centrifuge to eliminate bubbles and collect reagent at the bottom of the tube.
MA2	-25°C to -15°C	Thaw at room temperature. Invert 10 times to mix, and then pulse centrifuge to eliminate bubbles and collect reagent at the bottom of the tube.
MSM	-25°C to -15°C	Thaw at room temperature. Invert 10 times to mix, and then pulse centrifuge to eliminate bubbles and collect reagent at the bottom of the tube.

- 3 Apply an MSA1 barcode label to a new 0.8 ml microplate (midi).

Procedure

- 1 If you do not already have a DNA plate, add DNA into either of the following:
 - ▶ Midi plate: 20 μl to each DNA well
 - ▶ TCY plate: 10 μl to each DNA well
 Apply a barcode label to the new DNA plate.
- 2 Add 20 μl MA1 into the MSA1 plate wells.
- 3 Transfer 4 μl DNA sample from the DNA plate to the corresponding wells in the MSA1 plate.
- 4 Add 4 μl 0.1N NaOH into each well of the MSA1 plate.
Refer to the following figure throughout the Make MSA1 process.

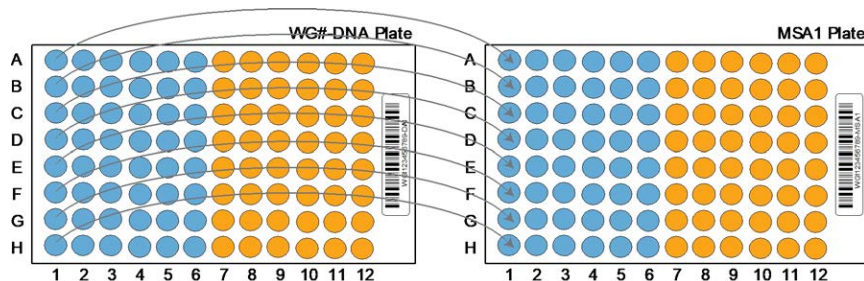

- 5 Seal the MSA1 plate with the 96-well cap mat.
 - ▶ Orient the mat so that A1 on the cap matches A1 on the plate.
 - ▶ Make sure that all 96 caps are securely seated in the wells.
- 6 Vortex the plate at 1600 rpm for 1 minute, and then pulse centrifuge at 280 × g.
- 7 Incubate at room temperature for 10 minutes.
- 8 Remove the cap mat and set aside upside down in a safe location.
- 9 Add 68 µl MA2 into each well of the MSA1 plate.
- 10 Add 75 µl MSM into each well of the MSA1 plate.
- 11 Reseal with the cap mat using the original orientation.
- 12 Vortex at 1600 rpm for 1 minute, and then pulse centrifuge at 280 × g.



NOTE

Perform the remaining protocol steps in the post-amplification area.

Incubate DNA

This step uniformly amplifies the genomic DNA, generating a sufficient quantity of each individual DNA sample to be used in the Infinium HD Super Assay.

- 1 Incubate the MSA1 plate in the Illumina Hybridization Oven for 20–24 hours at 37°C.

Fragment DNA

This step enzymatically fragments the DNA. An endpoint fragmentation is used to prevent overfragmentation.

Consumables

- ▶ FMS (2 tubes)
- ▶ Cap mat

Preparation

- 1 Preheat the heat block with the midi plate insert to 37°C.
- 2 Prepare the following consumable.

Item	Storage	Instructions
FMS	-25°C to -15°C	Thaw to room temperature. Invert 10 times to mix.

- 3 Remove the MSA1 plate from the Illumina Hybridization Oven.

Procedure

- 1 Pulse centrifuge the MSA1 plate at 280 × g.
- 2 Carefully remove the cap mat.
- 3 Add 50 µl FMS to each well of the MSA1 plate.
- 4 Reseal with the cap mat using the original orientation.
- 5 Vortex at 1600 rpm for 1 minute, and then centrifuge the plate at 280 × g.
- 6 Incubate on the preheated heat block for 1 hour.
If you are continuing, you can leave the plates on the heat block until you have completed preparation for the next step, no longer than 2 hours.

SAFE STOPPING POINT

If you are stopping, seal the plate, and store at -25°C to -15°C for up to 24 hours.

Precipitate DNA

This step uses 100 % 2-propanol and PM1 to precipitate the DNA.

Consumables

- ▶ 100% 2-propanol
- ▶ PM1(2 tubes)
- ▶ Cap mat

Preparation

- 1 Do one of the following:
 - ▶ If proceeding immediately from *Fragment DNA*, leave the MSA1 plate on the heat block until preparation is complete.
 - ▶ If the MSA1 plate was stored at -25°C to -15°C, thaw at room temperature, pulse centrifuge at 280 × g, and preheat the heat block to 37°C.
- 2 Prepare the following consumable.

Item	Storage	Instructions
PM1	2°C to 8°C	Thaw to room temperature and invert 10 times to mix.

- 3 Remove the cap mat.

Procedure

- 1 Add 100 µl PM1 to each well of the MSA1 plate.
- 2 Reseal with the cap mat using the original orientation.
- 3 Vortex the plate at 1600 rpm for 1 minute.
- 4 Incubate on the preheated heat block for 5 minutes.
- 5 Pulse centrifuge at 280 × g for 1 minute.
- 6 Set the centrifuge at 4°C in preparation for the next centrifuge step.

- 7 Remove and discard the cap mat.
- 8 Add 300 μ l 100% 2-propanol to each sample well.
- 9 Carefully seal with a **new, dry** cap mat. Avoid shaking the plate until the cap mat is seated.
- 10 Invert the plate 10 times to mix.
- 11 Incubate in a refrigerator set at 4°C for 30 minutes.
- 12 Centrifuge at 3000 \times g at 4°C for 20 minutes.
- 13 Immediately remove the plate from the centrifuge.
 - ▶ When centrifuging is complete, proceed **immediately** to avoid dislodging the blue pellets.
 - ▶ If a delay occurs, repeat the 20 minute centrifuge.
- 14 Make sure that a blue pellet is present in the bottom of each sample well.
- 15 Remove and discard the cap mat.
- 16 Hold the plate over an absorbent pad and do as follows.
 - a Quickly invert to decant the supernatant.
 - b Drain liquid onto the absorbent pad, and then smack the plate down on a dry area of the pad.
- 17 Keeping the plate inverted, firmly tap until all wells are free of liquid (~1 minute). Do not allow supernatant to pour in to other wells.
- 18 Place the uncovered, inverted plate on the tube rack for 1 hour at room temperature to air-dry the pellets.
- 19 Make sure that a blue pellet is still present in the bottom of each sample well.
- 20 Keeping the plate inverted, use a Kimwipe to remove any residual alcohol draining from the wells of the plate or remaining on the surface of the plate.

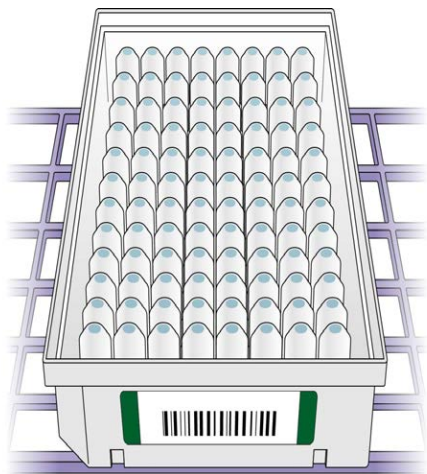

CAUTION

Do not overdry the pellets. Pellets that are overdried are difficult to resuspend and can lead to poor data quality.

SAFE STOPPING POINT

If you are stopping, seal the plate, and store at -25°C to -15°C for up to 24 hours.

Resuspend DNA

This step uses RA1 to resuspend the precipitated DNA.

Consumables

- ▶ RA1 (46 µl per well)
- ▶ Foil heat seals

About Reagents

- ▶ Dispense only the volume necessary for each step. The *Extend and Stain BeadChips* procedure also requires RA1.
- ▶ Use fresh RA1 for each step that requires it. Properly stored RA1 that has not been dispensed for this resuspension step or the extend and stain step is considered fresh.
- ▶ RA1 might form visible precipitate or crystals. Before each use, hold in front of a light and inspect. Invert several times to redissolve the solution as needed.



WARNING

This protocol uses an aliphatic amide that is a probable reproductive toxin. Personal injury can occur through inhalation, ingestion, skin contact, and eye contact. For more information, consult the material data safety sheet for this assay at www.illumina.com/sds. Dispose of containers and any unused contents in accordance with the governmental safety standards for your region.

Preparation

- 1 If the MSA1 plate was stored at -25°C to -15°C, thaw to room temperature, then remove cap mat.
- 2 Prepare the following consumable.

Item	Storage	Instructions
RA1	-25°C to -15°C	Warm to room temperature in a 20°C to 25°C water bath. Mix to dissolve any remaining crystals.

- 3 Preheat the Illumina Hybridization Oven to 48°C.
- 4 Preheat the heat sealer for at least 20 minutes before use.

Procedure

- 1 Add 46 µl RA1 to each well of the MSA1 plate.
- 2 With the dull side facing down, apply a foil heat seal to the plate. Hold the heat sealer sealing block down firmly and evenly for 5 seconds.
- 3 Incubate in the Illumina Hybridization Oven for 1 hour.
- 4 Vortex at 1800 rpm for 1 minute.
- 5 Pulse centrifuge at 280 × g.
- 6 Repeat steps 4 and 5 as needed to resuspend the pellets.
- 7 **[Optional]** Unless you are stopping, you can set aside the MSA1 plate for up to 1 hour before proceeding.

SAFE STOPPING POINT

If you are stopping, seal the plate, and store at -25°C to -15°C for up to 24 hours.

Hybridize to BeadChip

This step dispenses the fragmented, resuspended DNA onto BeadChips. Incubation then hybridizes each DNA sample to a section of the BeadChip.

Consumables

- ▶ 100 % EtOH (330 ml)
- ▶ PB2 (2 tubes)
- ▶ XC4

About Reagents

- ▶ Keep XC4 in the original bottle until you are ready to use it.
- ▶ Each XC4 bottle contains sufficient reagent to process up to 24 BeadChips.
- ▶ Use resuspended XC4 at room temperature.

Preparation

- 1 If frozen, thaw the MSA1 plate at room temperature, and then pulse centrifuge at 280 × g.
- 2 Preheat the heat block to 95°C.
- 3 Preheat the Illumina Hybridization Oven to 48°C.

Procedure

Denature DNA

- 1 Place the MSA1 plate on the preheated heat block for 20 minutes to denature the DNA.
- 2 Cool the MSA1 plate on the benchtop at room temperature for 30 minutes.
- 3 Pulse centrifuge at 280 × g.

Assemble the Hybridization Chambers

Assemble one chamber for every four BeadChips by following the steps in this section.

- 1 Place the hybridization chambers, hybridization chamber gaskets, and hybridization chamber inserts on the benchtop.

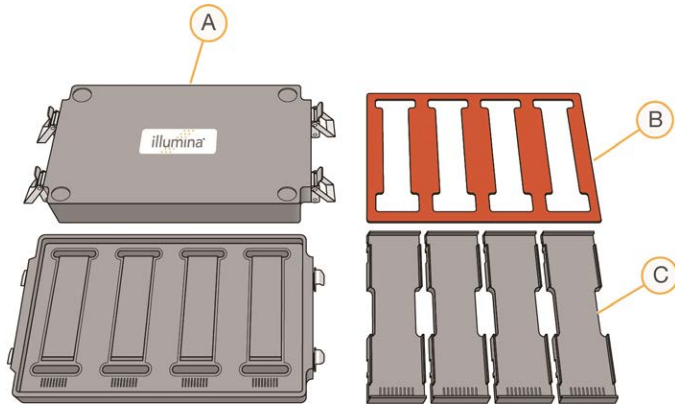

- A Hybridization chambers
- B Hybridization chamber gaskets
- C Hybridization chamber inserts

2 Align the wider edge of the gasket to the barcode ridges.

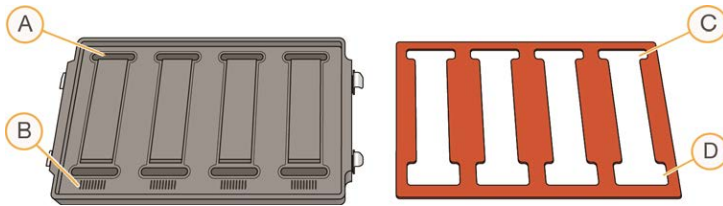

- A Reagent reservoirs
- B Barcode ridges
- C Narrower gasket edges
- D Wider gasket edges

3 Place the gasket into the hybridization chamber.

- ▶ Match the wider edge of the hybridization chamber gasket to the barcode-ridge side of the hybridization chamber.
- ▶ Press down on the edges of the gasket to make sure it is properly seated.



4 Make sure that the gaskets are properly placed and seated.

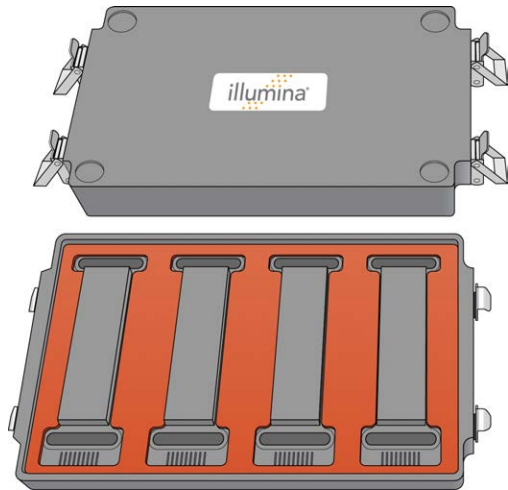

- 5 Add 400 μ l PB2 to the top and bottom wells of each beadchip subchamber in the hybridization chamber.

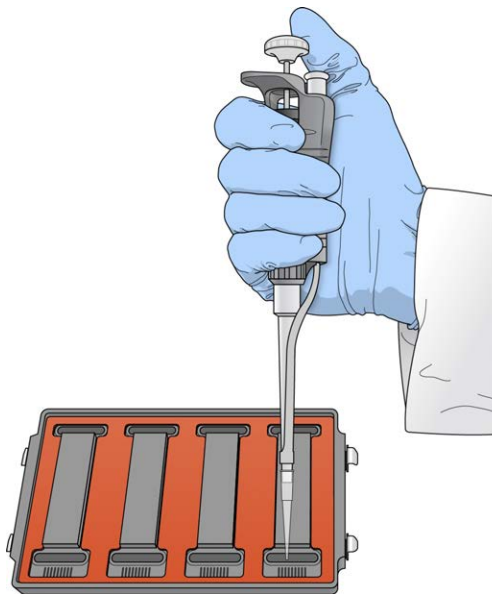

- 6 Immediately cover the chamber with the lid to prevent evaporation. Locking the lid is not necessary.
- 7 Leave the closed chambers on the benchtop at room temperature until the BeadChips are loaded with DNA (~1 hour).

Load BeadChip

- 1 Pulse centrifuge the MSA1 plate at $280 \times g$.
- 2 Remove the BeadChips from all packaging. Hold BeadChips by the ends, away from the sample inlets.
- 3 Place each BeadChip into an insert so that the barcode ends align.

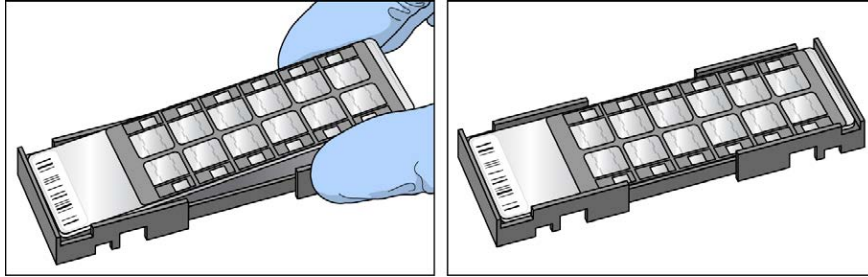

- 4 Remove the foil seal from the MSA1 plate.
- 5 Transfer sample from the MSA1 plate to the appropriate section of the BeadChip.
 - ▶ Insert the pipette into the sample inlet before dispensing.
 - ▶ Load A1–H1, as shown in the following graphic.

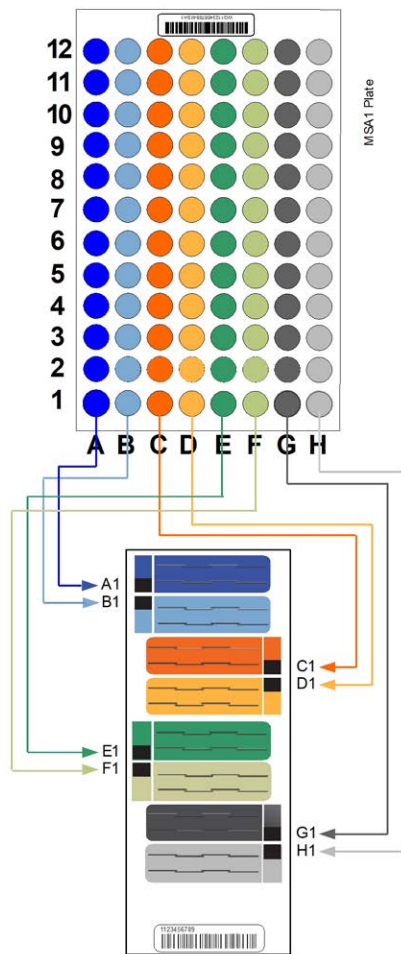

- 6 Wait for the DNA to disperse over the entire surface.
- 7 Inspect the loading port for excess liquid.

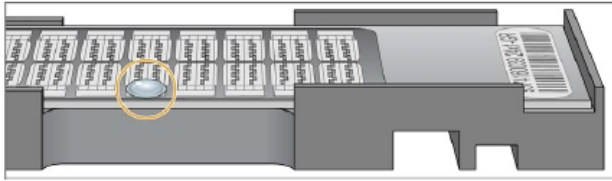

- 8 If excess liquid is not present, add leftover sample from the amplification plate to create a bolus around the loading port. Do not use RA1, which dilutes the sample. Excess liquid is desired because it prevents evaporation and the creation of low-intensity areas.
- 9 Heat-seal any residual sample in the MSA1 plate with foil and store plates at -25°C to -15°C for up to 24 hours. If more than 24 hours, store at -80°C.

Set up BeadChip for Hybridization

- 1 Load the inserts containing BeadChips into the hybridization chamber.
 - ▶ Position the barcode end over the ridges indicated on the chamber.
 - ▶ Keep the inserts steady and level.

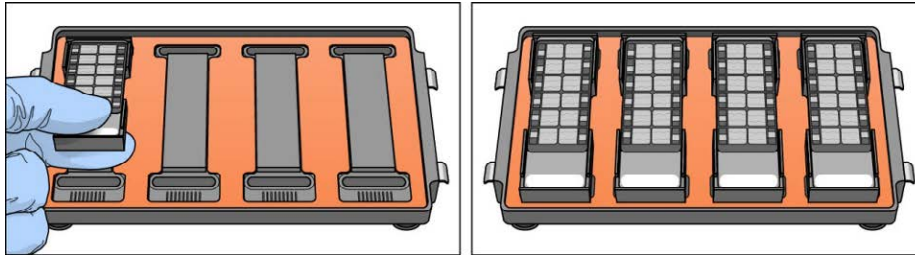

- 2 Place the back of the lid onto the chamber, and then slowly lower the front to avoid dislodging the inserts.

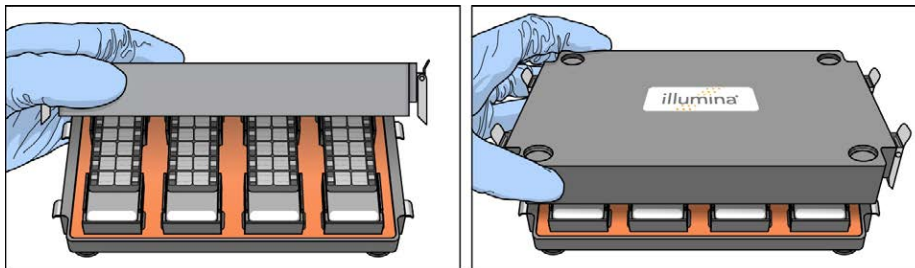

- 3 Close all four clamps so that the lid is secure and sits evenly on the base without any gaps. Close the clamps in the following order: top-left, bottom-right, top-right, bottom-left.
- 4 Place the chamber into the preheated Illumina Hybridization Oven so that the top logo faces you. You can stack up to three chambers per row for a total of six chambers. Make sure that the feet of the top chamber fit into the indents on the bottom chamber.

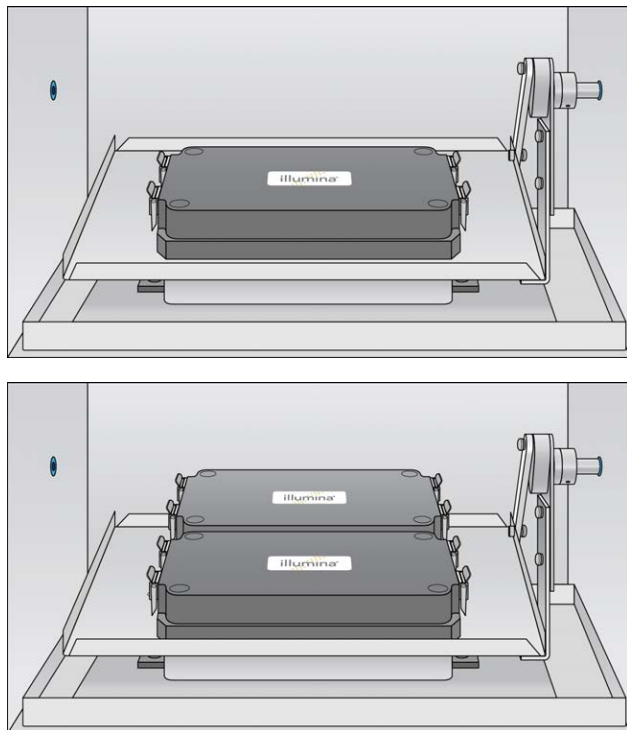

- 5 **[Optional]** Start the rocker, setting the speed to 5.
- 6 Incubate at 48°C for 16–24 hours.
- 7 Store RA1 at -25°C to -15°C for use the next day.

Resuspend XC4 Reagent

Resuspend XC4 to prepare for the *Extend and Stain BeadChips* step.

- 1 Add 330 ml 100% EtOH to the XC4 bottle.
The resulting volume is ~ 350 ml. Each XC4 bottle can process up to 24 BeadChips.
- 2 Resuspend XC4 using one of the following methods.
 - ▶ Leave the bottle upright on the lab bench overnight.
 - ▶ Add the 100% EtOH and place the XC4 on its side on a rocker to resuspend until the BeadChips are ready for coating.
- 3 **[Optional]** Store at 2°C to 8°C and use up to six times over a period of 2 weeks.

Wash BeadChips

This step prepares the BeadChips for the staining process.

Consumables

- ▶ 70 % EtOH (as needed)
- ▶ 95% formamide/1 mM EDTA (15 ml for up to 8 BeadChips, 17 ml for 16, 25 ml for 24)
- ▶ Alconox Powder Detergent (as needed)
- ▶ ATM (2 tubes per 8 BeadChips)

- ▶ PB1 (550ml for 1 alignment fixture, 700 ml for 2, or 850 for 3)
- ▶ RA1 (10 ml for up to 8 BeadChips, 20 ml for 16, 30 ml for 24)
- ▶ STM (2 tubes per 8 BeadChips)
- ▶ TEM (2 tubes per 8 BeadChips)
- ▶ XC1 (2 tubes per 8 BeadChips)
- ▶ XC2 (2 tubes per 8 BeadChips)
- ▶ XC3 (50 ml for up to 8 BeadChips, 100 ml for 16, 150 ml for 24)
- ▶ XC4 (310 ml for up to 8 BeadChips, 285 ml for 24)

About Reagents

- ▶ Decant only the reagent volume needed for each step. Some reagents are needed later in the protocol.
- ▶ Excepting PB1, all reagents are prepared in this step for use in a subsequent step.



WARNING

This protocol uses an aliphatic amide that is a probable reproductive toxin. Personal injury can occur through inhalation, ingestion, skin contact, and eye contact. For more information, consult the material data safety sheet for this assay at www.illumina.com/sds. Dispose of containers and any unused contents in accordance with the governmental safety standards for your region.

Preparation

- 1 Remove each hybridization chamber from the hybridization oven. Allow to cool for 30 minutes before opening.
- 2 Prepare the following items:
 - ▶ Fill two wash dishes with 200 ml PB1 each and label them Wash 1 and Wash 2.
 - ▶ Using a graduated cylinder, fill the Multi-Sample BeadChip Alignment Fixture with 150 ml PB1.
- 3 Remove the following Te-Flow flow-through chamber components from storage:
 - ▶ Black frames
 - ▶ Spacers (separated for ease of handling)
 - ▶ Clean glass back plates
 - ▶ Clamps
- 4 Prepare the following consumables for the subsequent *Extend and Stain BeadChips* step:

Item	Storage	Instructions
95% Formamide/1mM EDTA	-25°C to -15°C	Thaw at room temperature. Invert 10 times to mix.
ATM	-25°C to -15°C	Thaw at room temperature. Invert 10 times to mix.
TEM	-25°C to -15°C	Thaw at room temperature. Invert 10 times to mix.
PB1	Room temperature	Thaw at room temperature. Invert 10 times to mix.
RA1	-25°C to -15°C	Shake vigorously to resuspend. If necessary, vortex until dissolved.
STM	-25°C to -15°C	Thaw at room temperature. Invert 10 times to mix.
XC1	-25°C to -15°C	Thaw at room temperature. Invert 10 times to mix.

Item	Storage	Instructions
XC2	-25°C to -15°C	Thaw at room temperature. Invert 10 times to mix.
XC3	Room temperature	Thaw at room temperature. Invert 10 times to mix.
XC4	Room temperature	Thaw at room temperature. Invert 10 times to mix.

Procedure

Wash BeadChips

- 1 Attach the wire handle and submerge the wash rack in Wash 1 containing 200 ml PB1.



NOTE

Replace PB1 in Wash 1 after every 12 BeadChips.



- 2 Remove the hybridization chamber inserts from the hybridization chambers.
- 3 Remove the BeadChips from the hybridization inserts.
- 4 Remove the cover seals from the BeadChips.
Using powder-free gloved hands, hold the BeadChip securely and by the edges in one hand. Remove the entire seal in a single, continuous motion. Do not touch exposed arrays.

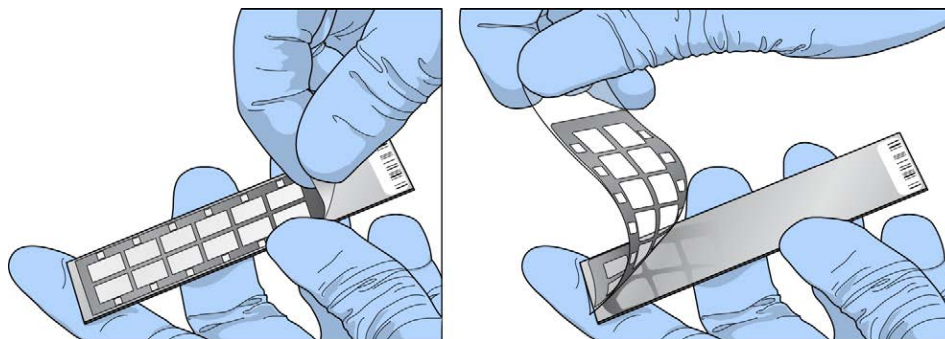

- 5 Immediately and carefully slide each BeadChip into the wash rack in Wash 1, making sure that the BeadChip is submerged in PB1 a maximum of 8 BeadChips).

- Repeat steps 4–5 until all BeadChips are transferred to the submerged wash rack in Wash 1.



- Move the wash rack up and down for 1 minute, breaking the surface of the PB1 with gentle, slow agitation.
- Move the wash rack to Wash 2 containing clean PB1, making sure that the BeadChips are submerged.
- Move the wash rack up and down for 1 minute, breaking the surface of the PB1 with gentle, slow agitation.
- Remove the BeadChips from the wash rack and inspect them for remaining residue. If you see residue, submerge the BeadChip in PB1 and carefully use a pipette tip to remove the remaining residue.

Assemble Flow-Through Chambers

- Confirm that you are using the correct Infinium glass back plates and spacers before proceeding.

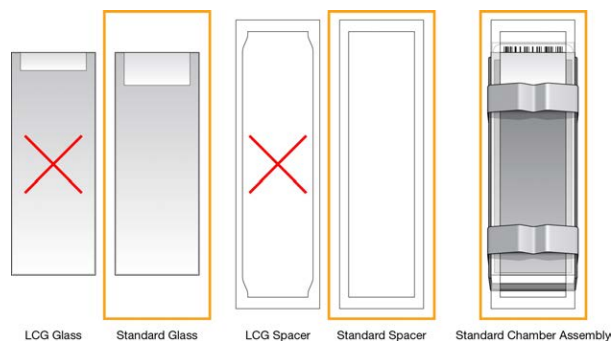

- Fill the BeadChip alignment fixture with 150 ml PB1 for up to 8 BeadChips.
- For each BeadChip, place one black frame into the BeadChip alignment fixture. For example, if you are processing four BeadChips, place four black frames into the fixture.



- 4 Place each BeadChip into a black frame, aligning the barcode with the alignment fixture ridges. Fully submerge each BeadChip.



- 5 Place a **clear** spacer onto the top of each BeadChip. Use the alignment fixture grooves to guide the spacers into position.
The white spacers are not a substitute for the clear spacers.

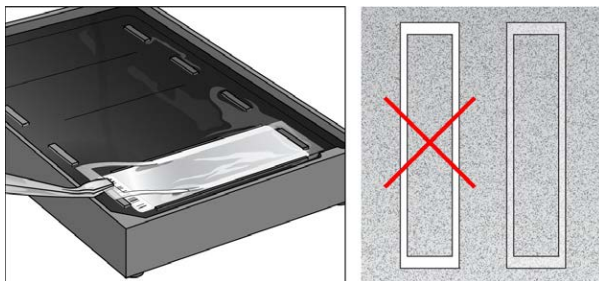

- 6 Place the alignment bar onto the alignment fixture. Fit the groove on the alignment bar over the tab on the alignment fixture.

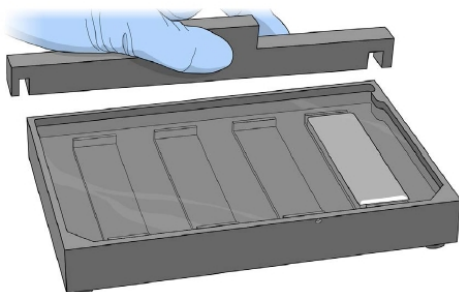

- 7 Place a clean glass back plate on top of each clear spacer. Position the plate reservoir at the barcode end of the BeadChip, facing inward to create a reservoir against the BeadChip surface.

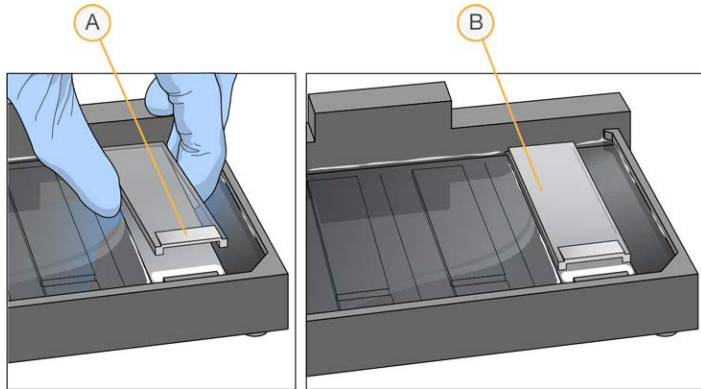

- A Reservoir at barcode end of glass back plate
- B Glass back plate in position

- 8 Secure each flow-through chamber assembly with metal clamps as follows.
 - a Using one finger, gently push the glass back plate against the alignment bar.
 - b Place a metal clamp around the flow-through chamber 5 mm from the top edge.
 - c Place a second metal clamp around the flow-through chamber at the barcode end, 5 mm from the bottom of the reagent reservoir.

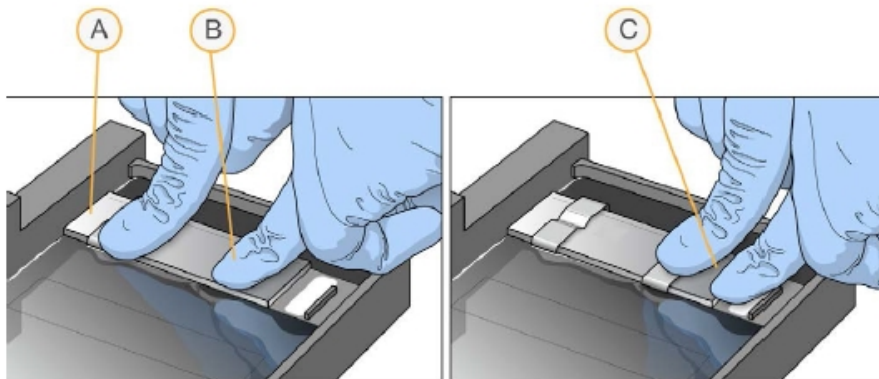

- A One stripe is visible between the first clamp and the alignment bar.
- B Glass back plate pressed against alignment bar.
- C Stripes are not visible between the second clamp and the barcode.

- 9 Remove the assembled flow-through chamber from the alignment fixture.
- 10 Starting at the nonbarcode end, trim the spacers from each end of the assembly using scissors.

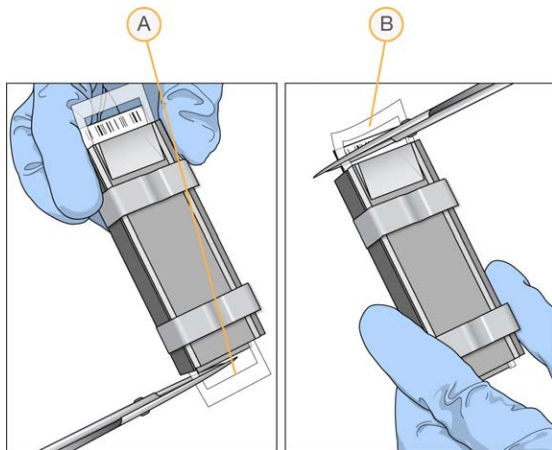

- A Trimming the spacer at the nonbarcode end.
- B Trimming the spacer at the barcode end.

- 11 Leave assembled flow-through chambers on the lab bench in a horizontal position until ready to load onto chamber rack in the *Extend and Stain BeadChips* step.
 - ▶ Do not place on absorbent paper.
 - ▶ Do not place in the chamber rack until instructed to do so.
- 12 Wash the hybridization chamber reservoirs with DI H₂O.
Immediate and thorough washing ensures complete removal of PB1 from the wells.

Extend and Stain BeadChips

This step washes unhybridized and nonspecifically hybridized DNA samples from the BeadChips, adds labeled nucleotides to extend primers hybridized to the sample, and stains the primers. After the flow-through chambers are disassembled, the BeadChips are coated for protection.

Consumables

- ▶ 70 % EtOH (as needed)
- ▶ 95% formamide/1 mM EDTA (15 ml for up to 8 BeadChips, 17 ml for 16, 25 ml for 24)
- ▶ Alconox Powder Detergent (as needed)
- ▶ ATM (2 tubes per 8 BeadChips)
- ▶ PB1 (310 ml for up to 8 BeadChips, 285 ml for 24)
- ▶ RA1 (10 ml for up to 8 BeadChips, 20 ml for 16, 30 ml for 24)
- ▶ STM (2 tubes per 8 BeadChips)
- ▶ TEM (2 tubes per 8 BeadChips)
- ▶ XC1 (2 tubes per 8 BeadChips)
- ▶ XC2 (2 tubes per 8 BeadChips)
- ▶ XC3 (50 ml for up to 8 BeadChips, 100 ml for 16, 150 ml for 24)
- ▶ XC4 (310 ml for up to 8 BeadChips, 285 ml for 24)

About Reagents

- ▶ Make sure that the label of each STM tube indicates the same stain temperature.
- ▶ Decant only the necessary volume of reagent.
- ▶ Use fresh RA1 for each step that requires it. Properly stored RA1 that has not been dispensed for the previous resuspension step or this extend and stain step is considered fresh.
- ▶ RA1 might form visible precipitate or crystals. Before each use, hold in front of a light and inspect. Invert several times to redissolve the solution as needed.
- ▶ The XC4 coat is slippery and makes the BeadChips difficult to hold. Self-locking tweezers grip the BeadChip firmly and help prevent damage.



WARNING

This protocol uses an aliphatic amide that is a probable reproductive toxin. Personal injury can occur through inhalation, ingestion, skin contact, and eye contact. For more information, consult the material data safety sheet for this assay at www.illumina.com/sds. Dispose of containers and any unused contents in accordance with the governmental safety standards for your region.

Preparation

- 1 Prepare the following consumable:

Item	Storage	Instructions
RA1	-25°C to -15°C	Thaw at room temperature.

- 2 Place reagent tubes in rack in order of use.

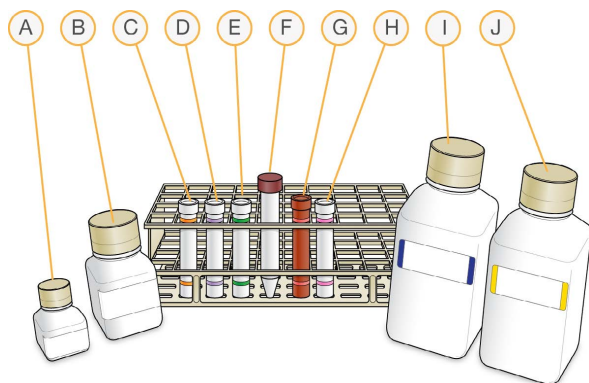

- A RA1
- B XC3
- C XC1
- D XC2
- E TEM
- F 95% Formamide / 1 mM EDTA
- G STM
- H ATM
- I PB1
- J XC4

Procedure

Set Up the Chamber Rack

- 1 Make sure that the water circulator is filled to the appropriate level. See the *VWR Operator Manual*, VWR part # 110-229.
- 2 Turn on the water circulator. Set it to a temperature that brings the Chamber Rack to 44°C at equilibrium. This temperature can vary depending on facility ambient conditions.

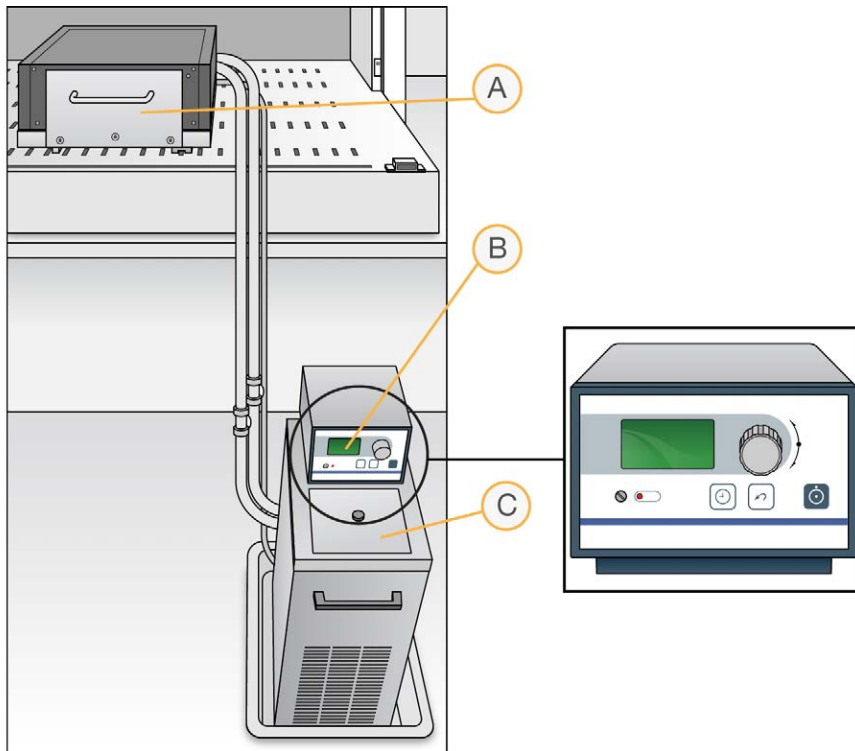

- A Chamber rack
- B Water circulator with programmable temperature controls
- C Reservoir cover

- 3 Confirm the actual temperature using the chamber rack temperature probe. The temperature displayed on the water circulator screen can differ from the chamber rack temperature.
- 4 Remove bubbles trapped in the chamber rack.
 - a Separate the heat exchanger from the reagent pan.
 - b Lift the heat exchanger upright and away from you with the tubing at the bottom, and turn 90° counter clockwise.
 - c Return the heat exchanger to a horizontal position.
 - d Repeat steps b and c 3 times for a total of 4 rotations or until all bubbles are removed.
 - e Using Kimwipes dampened with laboratory-grade water, clean all surfaces between the heat exchanger and reagent pan. Discard Kimwipes with formamide waste.
 - f Place the Te-Flow back on the reagent pan. Using the two guide pins in the reagent pan, make sure that the Te-Flow is flush.

- 5 Using the Illumina temperature probe, test at least three locations on the chamber rack.
 - a For accurate measurements, make sure that the temperature probe touches the base of the chamber rack.
 - b Make sure that all locations are at $44^{\circ}\text{C} \pm 0.5^{\circ}\text{C}$.
 - c If the temperature is not within $\pm 0.5^{\circ}\text{C}$, adjust the water circulator control knob to reach $44^{\circ}\text{C} \pm 0.5^{\circ}\text{C}$.
 - d Do not leave the temperature probe in the first three rows of the chamber rack. Reserve these rows for BeadChips.

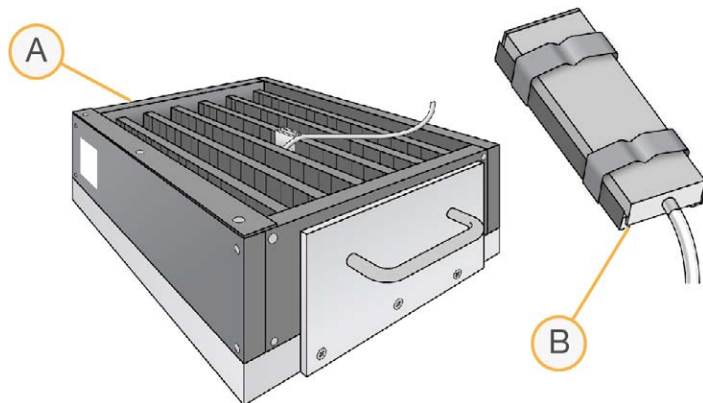

A Chamber rack with temperature probe
 B Temperature probe

Single-Base Extension

- 1 When the chamber rack reaches 44°C , quickly place the flow-through chamber assemblies into the chamber rack.



CAUTION

To avoid assay failure, complete this procedure without interruption.

- 2 Make sure that each flow-through chamber is properly seated on the rack to allow adequate heat exchange between the rack and the chamber.
- 3 Without allowing pipette tips to touch BeadChip surfaces, fill the reservoir of each flow-through chamber as follows.
 - a $150\ \mu\text{l}$ RA1. Incubate for 30 seconds. Repeat 5 times.
 - b $450\ \mu\text{l}$ XC1. Incubate for 10 minutes.
 - c $450\ \mu\text{l}$ XC2. Incubate for 10 minutes.
 - d $200\ \mu\text{l}$ TEM. Incubate for 15 minutes.
 - e $450\ \mu\text{l}$ 95% formamide/1 mM EDTA. Incubate for 1 minute. Repeat 1 time.
 - f Incubate 5 minutes.
 - g Set the the chamber rack temperature to the temperature indicated on the STM tube.
 - h $450\ \mu\text{l}$ XC3. Incubate for 1 minute. Repeat 1 time.

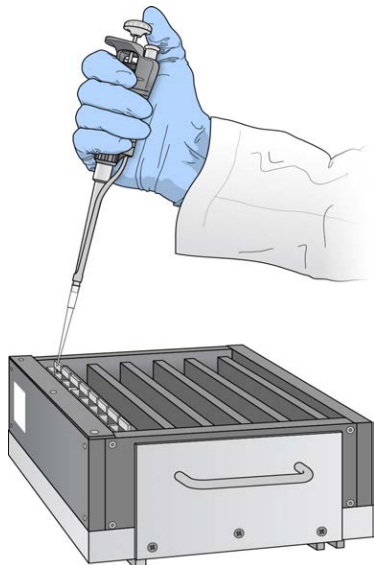

- 4 Wait for the chamber rack to reach the correct temperature.

Stain BeadChips

- 1 If you are imaging the BeadChip immediately after the staining process, turn on the scanner to allow the lasers to stabilize.
- 2 Fill the reservoir of each flow-through chamber as follows.
 - a 250 μ l STM. Incubate for 10 minutes.
 - b 450 μ l XC3. Incubate for 1 minute. Repeat 1 time..
 - c Wait 5 minutes.
 - d 250 μ l ATM. Incubate for 10 minutes.
 - e 450 μ l XC3. Incubate for 1 minute. Repeat 1 time.
 - f Wait 5 minutes.
 - g 250 μ l STM. Incubate for 10 minutes.
 - h 450 μ l XC3. Incubate for 1 minute. Repeat 1 time.
 - i Wait 5 minutes.
 - j 250 μ l ATM. Incubate for 10 minutes.
 - k 450 μ l XC3. Incubate for 1 minute. Repeat 1 time.
 - l Wait 5 minutes.
 - m 250 μ l STM. Incubate for 10 minutes.
 - n 450 μ l XC3. Incubate for 1 minute. Repeat 1 time.
 - o Wait 5 minutes.
- 3 Immediately remove the flow-through chambers from the chamber rack and place in reserved alignment fixtures submerged in PB1 at room temperature on a lab bench.

Wash and Coat BeadChips

- 1 Gather the following equipment:
 - ▶ Kimwipes, large
 - ▶ Staining rack

- ▶ Self-locking tweezers
 - ▶ Tube rack
 - ▶ Vacuum desiccator
 - ▶ Vacuum hose
 - ▶ Wash dishes (2)
- 2 During the procedure, prevent dust or lint from entering the wash dishes.
 - ▶ Clean wash dishes with low-pressure air before use.
 - ▶ Cover wash dishes with wash dish covers when not in use.
 - 3 Wash the tube racks and wash dishes thoroughly after each use.
 - ▶ Rinse with deionized water.
 - ▶ Dry racks and wash dishes upside down on a wash rack.
 - 4 Place a clean tube rack on top of several layers of Kimwipes or an absorbent pad. After the staining rack containing BeadChips is removed from the XC4 wash dish, it is placed on this rack.
 - 5 Prepare another clean tube rack that fits the internal dimensions of vacuum desiccator for removal of the BeadChips. Allow one rack per eight BeadChips. Kimwipes are not needed under this tube rack.
 - 6 Set up two top-loading wash dishes labeled PB1 and XC4.
 - 7 To indicate fill volume of each wash dish:
 - a Add 310 ml water.
 - b Mark the water level on the side.
 - c Empty the water.

Indicating fill volume before adding reagents allows reagents to be added directly from the bottles, minimizing contamination.

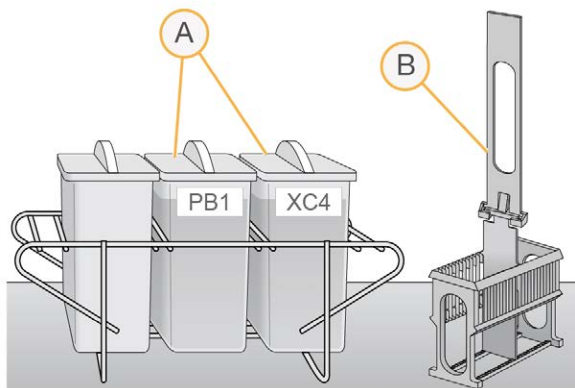

- A Labeled and filled wash dishes
- B Staining rack

- 8 Add 310 ml PB1 to the PB1 wash dish.
- 9 Submerge the staining rack in the wash dish so that the locking arms and tab **face you**. This orientation ensures that you can safely remove the BeadChips.

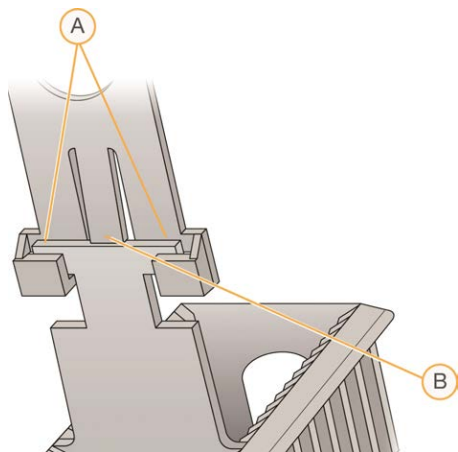

- A Locking arms
- B Tab

- 10 Leave the staining rack in the wash dish for later use (carrying the BeadChips after disassembling the flow-through chambers).
- 11 **Using the dismantling tool**, remove the two metal clamps from a flow-through chamber. The dismantling tool prevents chipping the glass back plates.

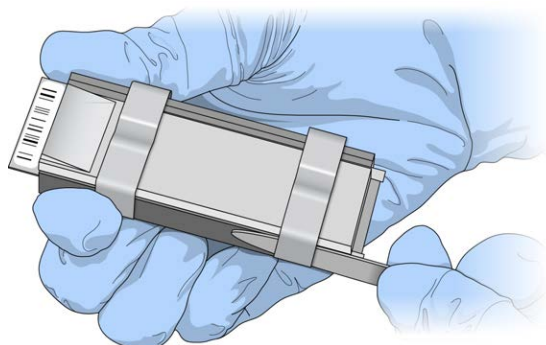

- 12 Lift the glass back plate straight up to remove. Set aside for cleaning after finishing this procedure. Sliding the glass along the BeadChip can damage the BeadChip.
- 13 Remove the spacer, avoiding contact with the BeadChip stripes.
- 14 Remove the BeadChip from the black frame. Handle the BeadChip only by the barcode end or edges.
- 15 Repeat steps 11–14 to disassemble each flow-through chamber one at a time.
- 16 Place the BeadChips into the submerged staining rack. Make sure that the BeadChip barcodes face **away** from you and the locking arms face **toward** you.



CAUTION

Submerge each BeadChip as quickly as possible to prevent drying.

- 17 If necessary to seat a BeadChip, briefly lift the staining rack from the wash dish and seat the BeadChip.
- 18 Make sure that the BeadChips are submerged.
- 19 Slowly move the staining rack up and down 10 times, breaking the PB1 surface. If the tops of the BeadChips touch, gently wiggle the staining rack to separate the slides.

Free circulation of PB1 between BeadChips is important.

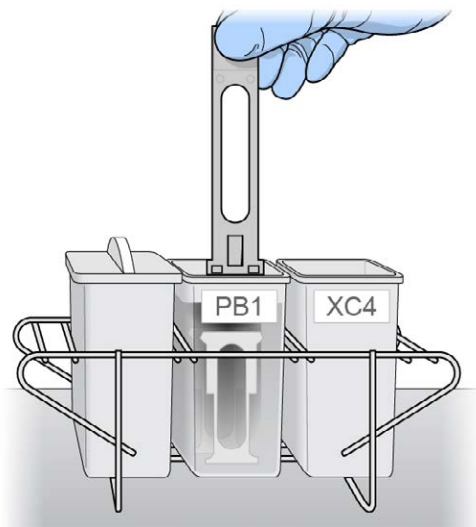

- 20 Soak for 5 minutes.
- 21 Vigorously shake the XC4 bottle to resuspend completely. If necessary, vortex until dissolved.
- 22 Add 310 ml XC4 to the XC4 wash dish.
 - ▶ Cover to prevent lint or dust from entering.
 - ▶ Do not let sit for more than 10 minutes.
- 23 Transfer the staining rack from the PB1 wash dish to the XC4 wash dish.

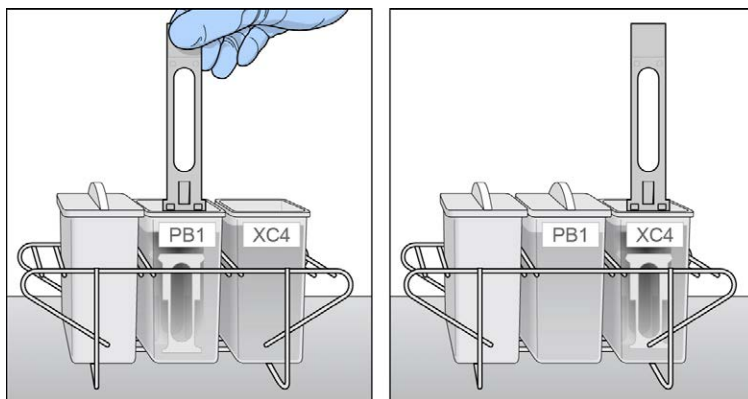

- 24 Slowly lift the staining rack up and down 10 times, breaking the XC4 surface. If the tops of the BeadChips touch, gently wiggle the staining rack to separate the slides.
- 25 Soak for 5 minutes.
- 26 Remove the staining rack in one quick motion and place it onto the prepared tube rack.

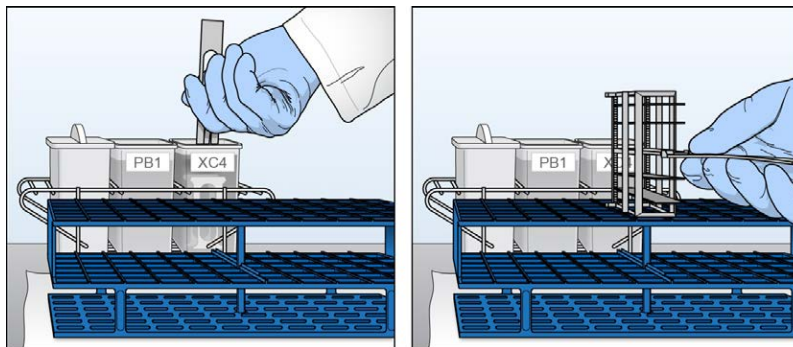

27 Make sure that the staining rack is in the center of the tube rack to ensure uniform coating. Avoid the raised edges.

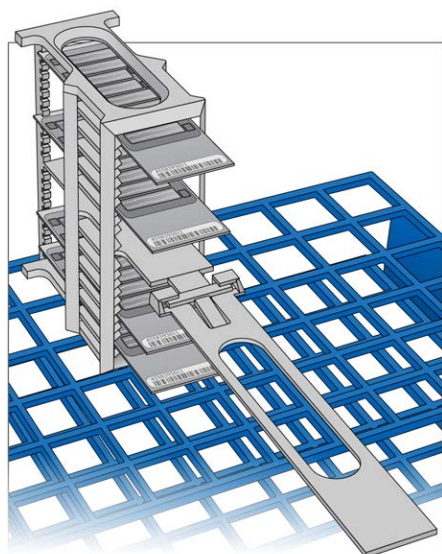

28 **[Optional]** Remove the staining rack handle to facilitate BeadChip removal:

- a Holding the top of the staining rack in position, grasp the handle between your thumb and forefinger.
- b Push up the tab with your thumb and push the handle away from you, unlocking the handle.
- c Pull up the handle and remove.

29 For each BeadChip, working top to bottom:

- a Holding the staining rack handle (if present), use self-locking tweezers to grip the BeadChip by the barcode end.
- b Place the BeadChip onto a tube rack with the barcode facing up and toward you. Do not place on the bottom rack or allow BeadChips to rest on the tube rack edge or touch each other.

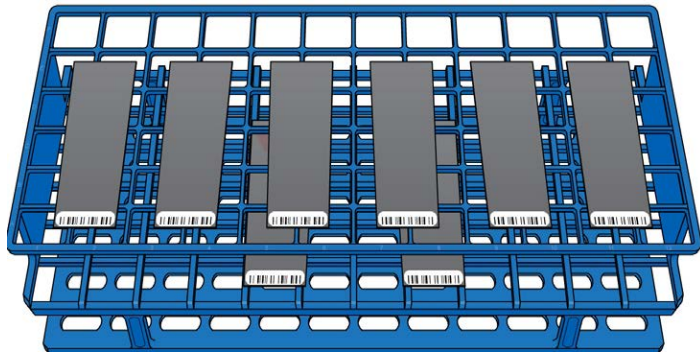

Proper BeadChip placement prevents wicking, uneven drying, and pooled dye protectant.

- 30 Place the tube rack into the vacuum desiccator.
Each desiccator can hold one tube rack (eight BeadChips).
- 31 Make sure that the vacuum desiccator valve is seated tightly and securely, and remove the red plug from the three-way valve.
- 32 Gently lift the vacuum desiccator lid to ensure proper sealing. Make sure that the lid does not lift off the desiccator base.
- 33 Dry the BeadChips in the vacuum desiccator for 50–55 minutes at 675 mm Hg (0.9 bar).
Drying times can vary according to room temperature and humidity.
- 34 Release the vacuum by turning the handle slowly.



WARNING

Make sure that air enters the desiccator very slowly to avoid disturbing the contents. Improper use of the vacuum desiccator can result in damage to the BeadChips, especially if you remove the valve plug while a vacuum is applied. For detailed vacuum desiccator instructions, see the documentation included with the desiccator.

- 35 Return the desiccator to storage. Store with the red valve plug in the three-way valve of the desiccator to prevent dust and lint from accumulating in the valve port.
- 36 Touch the edges of the BeadChips (**do not touch arrays**) to make sure etched, barcoded sides are dry.
- 37 Clean the back of each BeadChip using a Kimwipe sprayed with 70% EtOH:
 - a Hold the BeadChip at a downward angle to prevent excess EtOH from dripping onto the stripes.
 - b Without touching the stripes, wipe the underside of the BeadChip until XC4 is removed (5–6 times).
- 38 Clean the glass back plates.
For instructions, see the *Infinium Lab Setup and Procedures Guide* (document #11322460).

SAFE STOPPING POINT

Store the BeadChips in the Illumina BeadChip Slide Storage Box at room temperature. Scan within 72 hours.

Image BeadChip

Follow the instructions in the System Guide for your instrument to scan your BeadChips.

Use the **Infinium HD** scan setting for your BeadChip.

Illumina GenomeStudio

The Illumina GenomeStudio Genotyping Module, included with your Illumina Infinium Assay system, is an application for extracting genotyping data from intensity data files (*.idat files) collected from your Illumina scanning instrument.

For feature descriptions and instructions on using the GenomeStudio platform to visualize and analyze genotyping data, see the *GenomeStudio Framework User Guide* and the *GenomeStudio User Guide or online help*.

Chapter 3 Automated Protocol

Introduction	37
Infinium HD Super Automated Workflow	37
Amplify DNA	39
Incubate DNA	41
Fragment DNA	41
Precipitate DNA	42
Resuspend DNA	44
Hybridize to BeadChip	46
Wash BeadChips	53
Extend and Stain BeadChips	58
Image BeadChip	68
Illumina GenomeStudio	69

Introduction

This section describes pre- and post-amplification automated laboratory protocols for the Infinium HD Super Assay both with and without using the Illumina Illumina Laboratory Information Management System to track barcodes and other project information. Follow the protocols in the order shown. For information on using Illumina LIMS, see the *comprehensive User Guide*.

Infinium HD Super Automated Workflow

The following diagram illustrates the Infinium HD Super Assay automated workflow for 12 BeadChips. These protocols describe the procedure for preparing 96 DNA samples.

Figure 3 Infinium HD Super Automated Workflow



Amplify DNA

This step adds the DNA samples to the plates. The samples are denatured and neutralized to prepare them for amplification.

Consumables

- ▶ MA1 (2 tubes)
- ▶ MA2 (2 tubes)
- ▶ MSM (2 tubes)
- ▶ 0.1N NaOH (15 ml)
- ▶ 96-well 0.8 ml microplate (midi) (1 plate)
- ▶ DNA plate with 48 or 96 DNA samples (50 ng/μl) (midi or TCY) (1 plate)
- ▶ Cap mats

Preparation

- 1 Preheat the Illumina Hybridization Oven in the post-amp area to 37°C and allow the temperature to equilibrate.
- 2 Prepare the following consumables:

Item	Storage	Instructions
DNA	-25°C to -15°C	Thaw at room temperature. DNA must be 50 ng/μl, resuspended in TE (10 mM Tris, 1mM EDTA).
MA1	Room temperature	Thaw at room temperature. Invert 10 times to mix, and then pulse centrifuge to eliminate bubbles and collect reagent at the bottom of the tube.
MA2	-25°C to -15°C	Thaw at room temperature. Invert 10 times to mix, and then pulse centrifuge to eliminate bubbles and collect reagent at the bottom of the tube.
MSM	-25°C to -15°C	Thaw at room temperature. Invert 10 times to mix, and then pulse centrifuge to eliminate bubbles and collect reagent at the bottom of the tube.

- 3 Apply an MSA1 barcode label to a new midi plate.

Procedure

- 1 If you do not already have a DNA plate, add DNA into either of the following:
 - ▶ Midi plate: 20 μl to each DNA well
 - ▶ TCY plate: 10 μl to each DNA well
 Apply a barcode label to the new DNA plate.
- 2 At the robot PC, select **MSA1 Tasks | Make MSA1**.
- 3 In the Basic Run Parameters pane, enter the **Number of DNA plates**.
The robot PC updates the Required Run Items and the bed map to show the correct position of items on the robot bed.



NOTE

If you are using Illumina LIMS, you cannot change the number of DNA samples on this screen. The Illumina LIMS software processes the correct number of samples.



NOTE

If you are using Illumina LIMS, you must select **Run** and select batches before the robot bed map displays the correct layout for the DNA plates.

- 4 Remove caps from the MA1, MA2, and MSM tubes, then place the tubes in the robot tube rack according to the bed map.
- 5 Pour 15 ml NaOH into a trough. Place trough on robot bed according to bed map.
- 6 Place DNA and MSA1 plates on robot bed according to bed map.

Figure 4 Robot Setup for Make MSA1

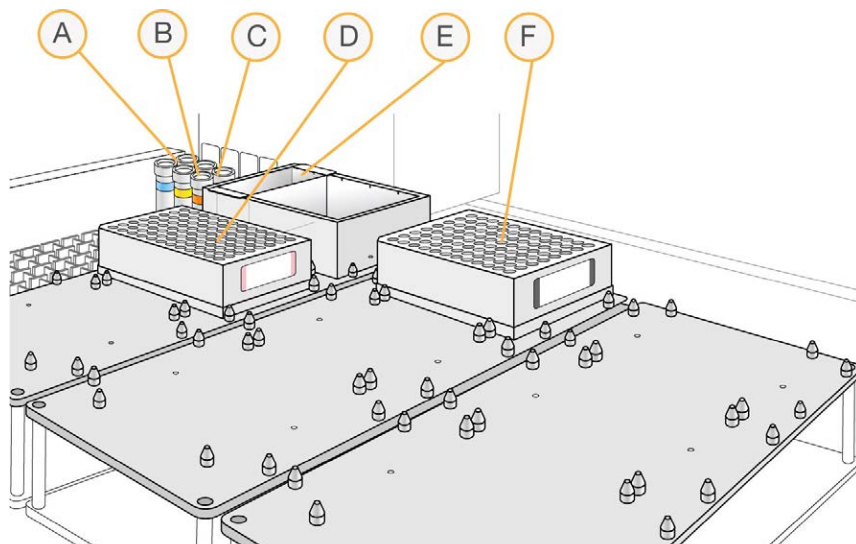

- A MA1 Tube
- B MA2 Tube
- C MSM Tube
- D MSA1 Plate
- E NaOH Trough
- F DNAPlate (MIDI)

- 7 At the robot PC, select **Run**.
- 8 When prompted, enter the barcode of each DNA plate.
The robot bed map is updated with the DNA plate locations.
- 9 Place the DNA plates on the robot bed according to the bed map and select **OK**. The robot begins when the plates are in place.
- 10 When the robot has completed the run, vortex the sealed MSA1 plate at 1600 rpm for 1 minute.
- 11 Centrifuge at $280 \times g$ at 22°C for 1 minute.
- 12 Remove the cap mat, place the MSA1 plate back on the robot bed, and select **OK**.
- 13 When the process is complete, select **OK**.
- 14 Remove and seal the MSA1 plate with a cap mat.
- 15 Vortex the sealed MSA1 plate at 1600 rpm for 1 minute.

16 Centrifuge at 280 × g for 1 minute.



NOTE

Perform the remaining protocol steps in the post-amplification area.

Incubate DNA

This step uniformly amplifies the genomic DNA, generating a sufficient quantity of each individual DNA sample to be used in the Infinium HD Super Assay.



NOTE

This and all remaining steps in the workflow are performed in the post-amp lab.

1 Incubate the MSA1 plate in the Illumina Hybridization Oven for 20–24 hours at 37°C.

Fragment DNA

This step enzymatically fragments the DNA. An endpoint fragmentation is used to prevent overfragmentation.

Consumables

- ▶ FMS (2 tubes)
- ▶ Cap mats

Preparation

- 1 Preheat the heat block with the midi plate insert at 37°C.
- 2 Prepare the following consumable.

Item	Storage	Instructions
FMS	-25°C to -15°C	Thaw to room temperature. Invert 10 times to mix.

- 3 Preheat the heat block with the midi plate insert at 37°C.
- 4 Remove the MSA1 plate from the Illumina Hybridization Oven.
- 5 If resuspending the MSA1 plate today, remove the RA1 from the freezer and thaw at room temperature.

Procedure

- 1 Pulse centrifuge the MSA1 plate at 280 × g.
- 2 At the robot PC, select **MSA1 Tasks | Fragment MSA1**.
- 3 Place the MSA1 plate on the robot bed according to the bed map. Remove the cap mat.

Figure 5 Robot Setup for Fragment MSA1

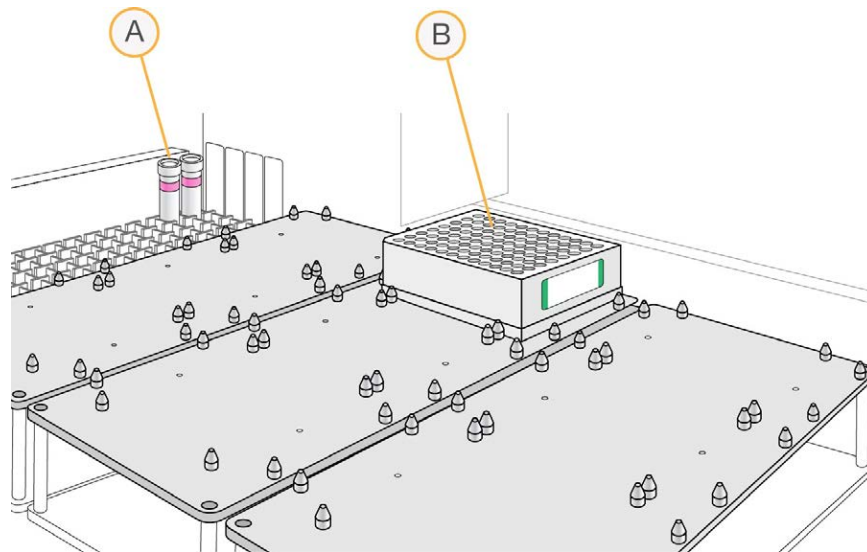

- A FMS
- B MSA1 Plate

- 4 Place FMS tubes in the robot tube rack according to the bed map. Remove the cap mat.
- 5 At the robot PC, select **Run**.
- 6 When the process completes, select **OK**.
- 7 Remove the plate from the robot bed and seal with a cap mat.
- 8 Vortex at 1600 rpm for 1 minute.
- 9 Pulse centrifuge at 280 × g.
- 10 Place the sealed plate on the 37°C heat block for 1 hour.
If you are continuing, leave the plate in the 37°C heat block until you have completed preparation for the next step. Do not leave the plate on the heat block for longer than 2 hours.

SAFE STOPPING POINT

If you are stopping, seal the plate(s), and store at -25°C to -15°C.

Precipitate DNA

This step uses 100% 2-propanol and PM1 to precipitate the DNA.

Consumables

- ▶ 100% 2-propanol
- ▶ PM1(2 tubes)
- ▶ Cap mat

Preparation

- 1 Do one of the following:

- ▶ If proceeding immediately from *Fragment DNA*, leave the MSA1 plate on the heat block until preparation is complete.
- ▶ If the MSA1 plate was stored at -25°C to -15°C, thaw at room temperature, pulse centrifuge at 280 × g, and preheat the heat block to 37°C.

2 Prepare the following consumables:

Item	Storage	Instructions
PM1	2°C to 8°C	Thaw at room temperature and invert to mix. Centrifuge at 280 × g for 1 minute.
100% 2-propanol	Room temperature	Allow to equilibrate. Invert 10 times to mix. Pulse centrifuge at 280 × g for 1 minute.

3 Remove the cap mat.

Procedure

- 1 At the robot PC, select **MSA1 Tasks | Precip MSA1**.
- 2 Pulse centrifuge the sealed plate at 280 × g.
- 3 Remove the cap mat and place the MSA1 plate on the robot bed according to the bed map.
- 4 Place a half reservoir in the reservoir frame according to the robot bed map, and add PM1 as follows:
 - ▶ For 48 samples, add 1 tube PM1
 - ▶ For 96 samples, add 2 tubes PM1

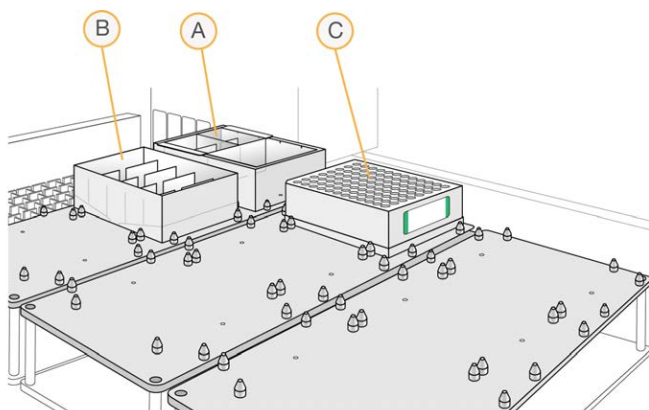

- A PM1 in Half Reservoir
- B 2-Propanol in Full Reservoir
- C MSA1 Plate

- 5 At the robot PC, select **Run**.
- 6 When prompted, remove the MSA1 plate from the robot bed. Do not select **OK**.
- 7 Reseal the MSA1 plate with the cap mat.
- 8 Vortex at 1600 rpm for 1 minute.
- 9 Incubate on the preheated heat block for 5 minutes.
- 10 Pulse centrifuge at 280 × g for 1 minute.
- 11 Set the centrifuge at 4°C to prepare for the next centrifuge step.

- 12 Remove and discard the cap mat.
- 13 Place the MSA1 plate back on the robot bed according to the bed map.
- 14 When prompted, select **OK**.
- 15 Remove the MSA1 plate from the robot bed and carefully seal with a **new, dry** cap mat. Avoid shaking the plate until the cap mat is seated.
- 16 Invert 10 times to mix.
- 17 Incubate at 4°C for 30 minutes.
- 18 Place in the centrifuge opposite another plate of equal weight.
- 19 Centrifuge at 3000 × g for 20 minutes.
 - ▶ When centrifuging is complete, proceed **immediately** to the next step to avoid dislodging the blue pellet.
 - ▶ If a delay occurs, repeat the 20 minute centrifuge.
- 20 Remove MSA1 plate from centrifuge.
- 21 Make sure that a blue pellet is present in the bottom of each sample well.
- 22 Remove and discard the cap mat.
- 23 Hold the plate over an absorbent pad and do as follows.
 - a Quickly invert to decant the supernatant.
 - b Drain liquid onto the absorbent pad, and then smack the plate down. Avoid the liquid drained onto the pad.
- 24 Keeping the plate inverted, firmly tap until all wells are free of liquid (~1 minute). Do not allow supernatant to pour into other wells.
- 25 Place the uncovered, inverted plate on a tube rack for 1 hour at room temperature to air-dry the pellet.
- 26 Make sure that a blue pellet is still present in the bottom of each sample well.

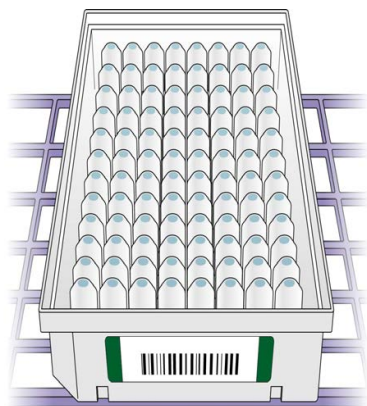

SAFE STOPPING POINT

If you are stopping, seal the plate(s), and store at -25°C to -15°C.

Resuspend DNA

This step uses RA1 to resuspend the precipitated DNA.

Consumables

- ▶ RA1 (9 ml per 96 samples)
- ▶ Foil heat seals



WARNING

This protocol uses an aliphatic amide that is a probable reproductive toxin. Personal injury can occur through inhalation, ingestion, skin contact, and eye contact. For more information, consult the material data safety sheet for this assay at www.illumina.com/sds. Dispose of containers and any unused contents in accordance with the governmental safety standards for your region.

Preparation

- 1 If the MSA1 plate was stored at -25°C to -15°C, thaw at room temperature, and then remove the cap mats.
- 2 Prepare the following consumable:

Item	Storage	Instructions
RA1	-25°C to -15°C	Thaw at room temperature and invert to mix.

- 3 Preheat the Illumina Hybridization Oven to 48°C.
- 4 Preheat the heat sealer for at least 20 minutes before use.

Procedure

- 1 At the robot PC, select **MSA1 Tasks | Resuspend MSA1**.
- 2 Place the MSA1 plate on the robot bed according to the bed map.

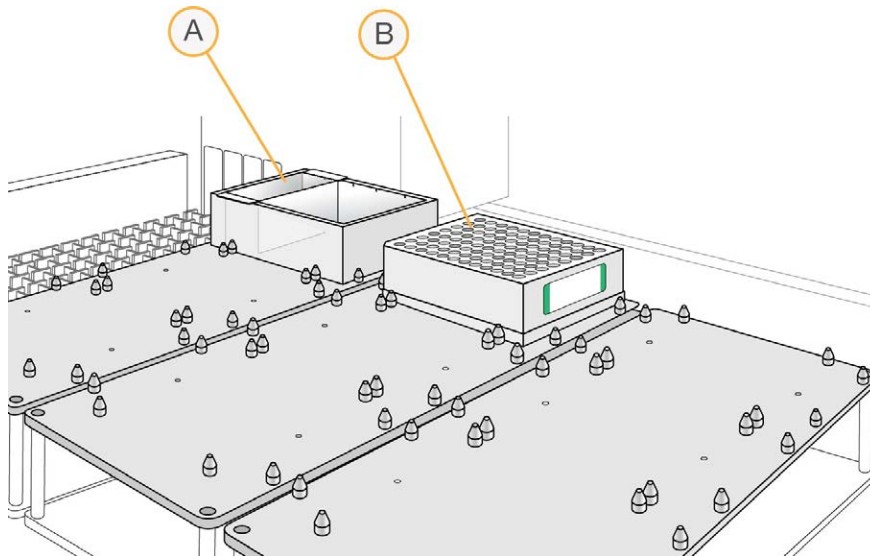

- A RA1 in Quarter Reservoir
- B MSA1 Plate

- 3 Place a quarter reservoir in the reservoir frame according to the robot bed map, and add RA1 as follows:

- ▶ For 48 samples, add 4.5 ml RA1
 - ▶ For 96 samples, add 9 ml RA1
- 4 At the robot PC, select **Run**.
 - 5 Remove the MSA1 plate from the robot deck.
 - 6 Apply a foil seal to the MSA1 plate using the heat sealer.
 - 7 Incubate in the preheated Illumina Hybridization Oven for 1 hour.
 - 8 Vortex the plate at 1800 rpm for 1 minute.
 - 9 Check to make sure that the pellets are resuspended. If necessary, repeat the incubation and vortexing steps.
 - 10 Pulse centrifuge at 280 × g.

SAFE STOPPING POINT

If you are stopping, store sealed MSA1 plate(s) at 2°C to 8°C for up to 24 hours. If more than 24 hours, store at -25°C to -15°C.

Store sealed RA1 at -25°C to -15°C. If RA1 will be used the next day, seal it, and store it overnight at 4°C.

Hybridize to BeadChip

This step dispenses the fragmented, resuspended DNA onto BeadChips. Incubation then hybridizes each DNA sample to a section of the BeadChip.

Consumables

- ▶ 1% aqueous Alconox solution
- ▶ 100% EtOH
- ▶ DI H₂O
- ▶ PB2 (3 tubes (1 tube per 4 BeadChips))
- ▶ XC4

Preparation

- 1 If frozen, thaw the MSA1 plate at room temperature, and then centrifuge at 280 × g for 1 minute.
- 2 Remove BeadChips from storage, but do not unpackage.
- 3 Preheat the heat block to 95°C.
- 4 Preheat the Illumina Hybridization Oven to 48°C.

Prepare Robot Tip Alignment Guide

- 1 Make sure you have the correct robot tip alignment guide for the assay.
The barcode says **Guide-E**

Figure 6 Guide E Robot Tip Alignment Guide

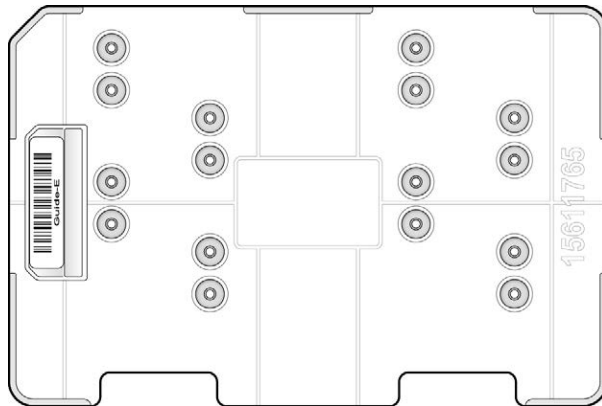

- 2 Wash and dry the robot tip alignment guide. For washing instructions, see *Wash Robot Tip Alignment Guide on page 1*.

Procedure

Denature DNA

- 1 Place the MSA1 plate on the preheated heat block for 20 minutes to denature the DNA.
- 2 Cool the MSA1 plate on the benchtop at room temperature for 30 minutes.
- 3 Pulse centrifuge at $280 \times g$.

Assemble Hybridization Chambers

Assemble one chamber for every four BeadChips by following the steps in this section.

Figure 7 BeadChip Hybridization Chamber Components

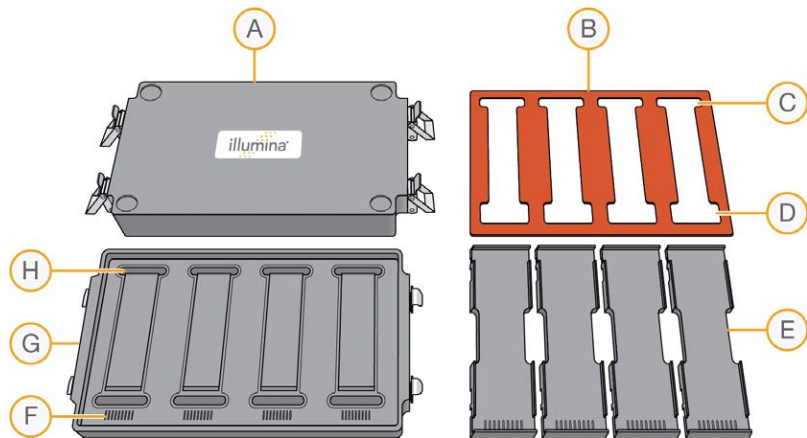

- A Top of BeadChip Hybridization Chamber
- B Hybridization Chamber Gasket
- C Narrower Edges
- D Wider Edges
- E Hybridization Chamber Inserts
- F Barcode Ridges
- G Bottom of BeadChip Hybridization Chamber
- H Humidifying Buffer Reservoirs

- 1 Place the gasket into the hybridization chamber.
 - ▶ Match the wider edge of the hybridization chamber gasket to the barcode-ridge side of the hybridization chamber.
 - ▶ Press down on the edges of the gasket to make sure it is properly seated.



- 2 Add 400 μ l PB2 into each of the eight humidifying buffer reservoirs in the hybridization chamber.
- 3 Place the hybridization chamber insert into the hybridization chamber. Position the barcode ridges on the hybridization chamber insert over the barcode ridges on the hybridization chamber.

- 4 Immediately cover the chamber with the lid to prevent evaporation.
- 5 Leave the closed chambers on the benchtop at room temperature until the BeadChips are loaded with DNA (~1 hour).
- 6 **[Illumina LIMS]** Select **Infinium HD Super | Confirm for Hyb.**
 - a Scan the barcode of each MSA1 plate you plan to hybridize.
 - b Scan the BeadChip barcode on the package of each BeadChip you plan to hybridize.
 - c Select **Verify**.

Prepare the Robot

- 1 Remove all BeadChips from packaging.
- 2 Place BeadChips into the robot BeadChip alignment fixtures. Align the barcode end with the ridges stamped into the robot BeadChip alignment fixture.

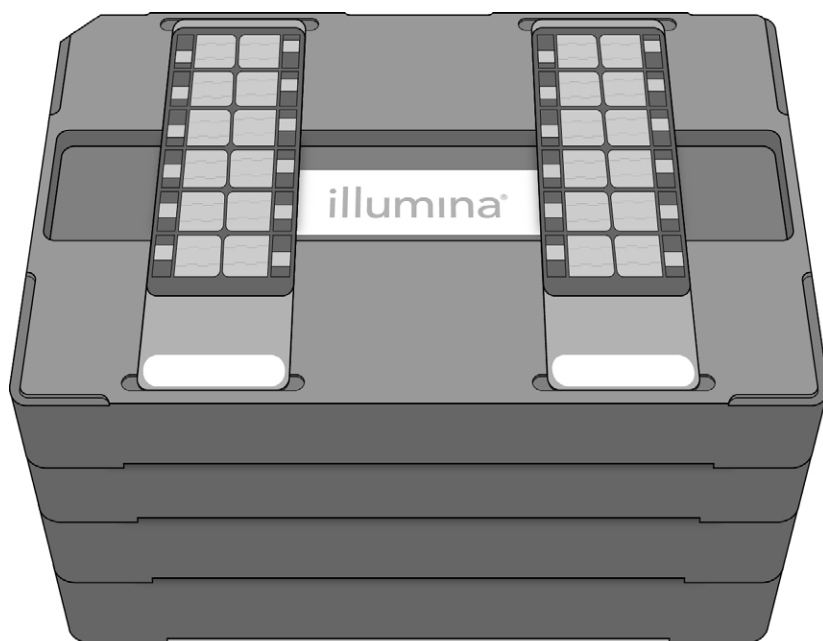

- 3 Stack the robot BeadChip alignment fixtures and carry them to the robot.
- 4 Place the robot BeadChip alignment fixtures onto the robot deck according to the deck map in [Figure 8](#).
- 5 Pulse centrifuge the MSA1 plate at $280 \times g$.
- 6 Place the MSA1 plate onto the robot deck according to the deck map, and remove the heat seal.

Figure 8 Robot Deck Setup for Hybridization*

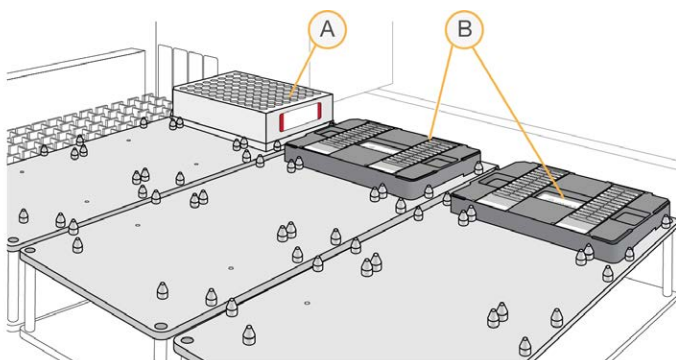

- A MSA1 Plate
- B Robot BeadChip Alignment Fixtures



CAUTION

BeadChips must be transferred to hybridization chambers immediately at the end of the next procedure (*Start the Robot*). Do not begin *Start the Robot* if you cannot immediately transfer the BeadChips.

Start the Robot

- 1 At the robot PC, select **Run**.
 - ▶ The robot scans the barcode on the BeadChips to confirm the correct BeadChips are loaded.
- 2 Place each robot tip alignment guide on top of each robot BeadChip alignment fixture.
 - a Make sure that the Guide-E barcode is upside down and facing away from you.
 - b Push both the tip guide and alignment fixture to the upper left corner in its section of the robot bed.

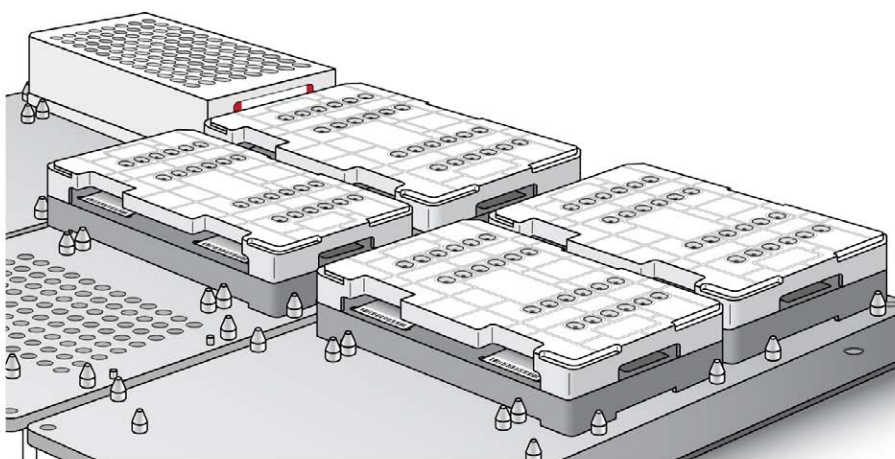

- 3 At the robot PC, select **OK**.
 - ▶ The robot scans the barcode on the robot tip alignment guide to confirm that the correct tip guide is being used.
 - ▶ The robot dispenses DNA sample to the BeadChips.
 - ▶ When the process is complete, the robot PC sounds an alert and opens a message box.

- 4 When the robot finishes, at the robot PC, select **OK**.
- 5 Remove the robot BeadChip alignment fixtures from the robot deck.
- 6 Make a record of any sections of BeadChip stripes without complete DNA sample coverage.



CAUTION

BeadChips must be removed from the robot deck immediately to prevent excess sample evaporation. Proceed to the next section (*Set Up and Incubate BeadChips*) immediately.

Set up and Incubate BeadChips

- 1 Make sure that the Illumina Hybridization Oven is set to 48°C.



WARNING

Keep hybridization chambers at room temperature when you load the BeadChips. Do not place the hybridization chamber in the Illumina Hybridization Oven when loading the BeadChips.

- 2 Open each hybridization chamber, and then carefully place each BeadChip in a hybridization chamber insert.

Orient the barcode end so that it matches the barcode symbol on the Hyb Chamber Insert.

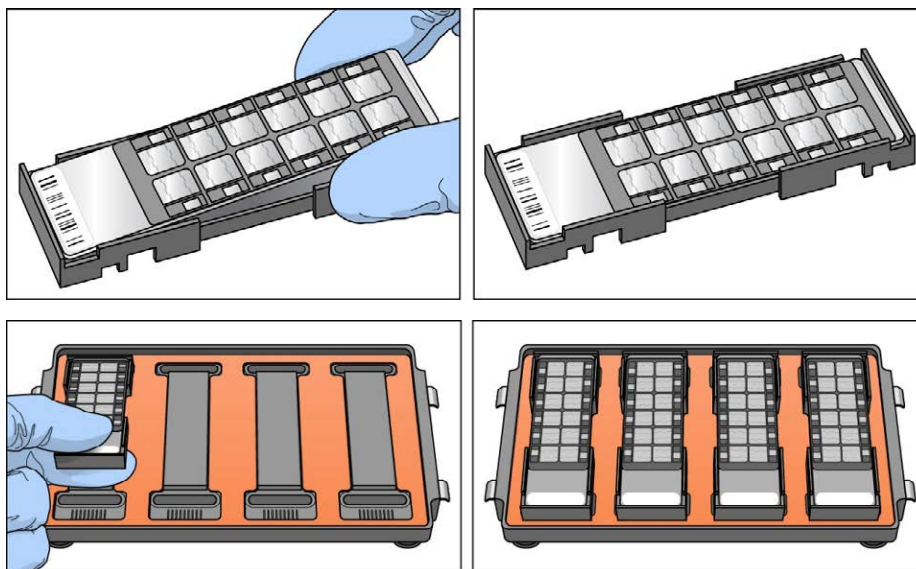

- 3 Make sure that hybridization chamber inserts are seated properly in the hybridization chambers.
- 4 Apply the back side of the hybridization chamber lid first, and then slowly bring down the front end to avoid dislodging the hybridization chamber inserts.

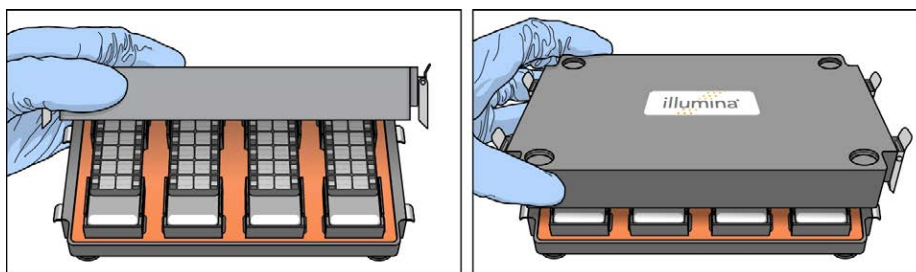

- 5 Close the hybridization chamber clamps in this order: top-left, bottom-right, top-right, and then bottom-left. Make sure that the lid is secure and even on the base (no gaps).



CAUTION

Keep the hybridization chamber steady and level when moving it or transferring it to the Illumina Hybridization Oven.

- 6 **[Illumina LIMS] Select Infinium HD Super | Prepare Hyb Chamber.**

- a Scan the barcode of the PB2 bottles.
- b Scan the BeadChip barcode on each BeadChip package.
- c Select **Verify**, and then select **Save**.

- 7 Place the hybridization chamber in the preheated Illumina Hybridization Oven with the clamps of the hybridization chamber facing the front and back of the oven.

If you are stacking multiple hybridization chambers in the Illumina Hybridization Oven, fit the feet of each hybridization chamber into the matching indents on the lid of the hybridization chamber below it. You can stack up to 3 hybridization chambers in two rows, for a maximum of 6 total hybridization chambers in the Illumina Hybridization Oven.

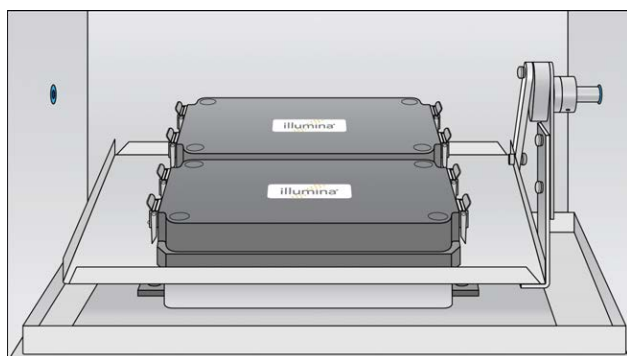
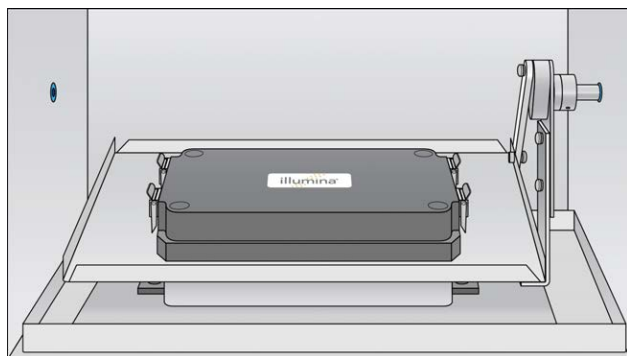

- 8 [Optional] Start the rocker, setting the speed to 5.

OVERNIGHT INCUBATION

Incubate at 48°C for 16–24 hours.

Resuspend XC4 Reagent

Resuspend XC4 to prepare for the *Extend and Stain BeadChips* step.

- 1 Add 330 ml 100% EtOH to the XC4 bottle.

The resulting volume is ~ 350 ml. Each XC4 bottle can process up to 24 BeadChips.

- 2 Resuspend XC4 using one of the following methods.
 - ▶ Leave the bottle upright on the lab bench overnight.
 - ▶ Add the 100% EtOH and place the XC4 on its side on a rocker to resuspend until the BeadChips are ready for coating.
- 3 **[Optional]** Store at 2°C to 8°C and use up to six times over a period of 2 weeks.

Wash Robot Tip Alignment Guide

For optimal performance, wash and dry the Alignment Guide after each use.

- 1 Soak the tip guide inserts in a 1% aqueous Alconox solution (1 part Alconox to 99 parts water) for 5 minutes. Do not use bleach or ethanol to clean tip guides.
- 2 Thoroughly rinse the tip guides with DiH₂O at least 3 times to remove any residual detergent.
- 3 Dry the tip guide and make sure that they are free of any residual contaminants before next use.

Wash BeadChips

This step prepares the BeadChips for the staining process.

Consumables

- ▶ 95% Formamide/1 mM EDTA
- ▶ ATM
- ▶ TEM
- ▶ PB1
- ▶ ATM
- ▶ STM
- ▶ XC1
- ▶ XC2
- ▶ XC3
- ▶ XC4

About Reagents

- ▶ Decant only the reagent volume needed for each step. Some reagents are needed later in the protocol.
- ▶ Excepting PB1, all reagents are prepared in this step for use in a subsequent step.



WARNING

This set of reagents contains potentially hazardous chemicals. Personal injury can occur through inhalation, ingestion, skin contact, and eye contact. Wear protective equipment, including eye protection, gloves, and laboratory coat appropriate for risk of exposure. Handle used reagents as chemical waste and discard in accordance with applicable regional, national, and local laws and regulations. For additional environmental, health, and safety information, see the SDS at support.illumina.com/sds.html.

Preparation

- 1 Remove each hybridization chamber from the hybridization oven. Allow to cool for 30 minutes before opening.
- 2 Prepare the following items:
 - ▶ Fill two wash dishes with 200 ml PB1 each and label them Wash 1 and Wash 2.
 - ▶ Using a graduated cylinder, fill the Multi-Sample BeadChip Alignment Fixture with 150 ml PB1.
- 3 Remove the following Te-Flow flow-through chamber components from storage:
 - ▶ Black frames
 - ▶ Spacers (separated for ease of handling)
 - ▶ Clean glass back plates
 - ▶ Clamps
- 4 Prepare the following consumables for the subsequent *Extend and Stain BeadChips* step:

Item	Storage	Instructions
95% Formamide/1mM EDTA	-25°C to -15°C	Thaw at room temperature. Invert 10 times to mix.
ATM	-25°C to -15°C	Thaw at room temperature. Invert 10 times to mix.
TEM	-25°C to -15°C	Thaw at room temperature. Invert 10 times to mix.
PB1	Room temperature	Thaw at room temperature. Invert 10 times to mix.
RA1	-25°C to -15°C	Shake vigorously to resuspend. If necessary, vortex until dissolved.
STM	-25°C to -15°C	Thaw at room temperature. Invert 10 times to mix.
XC1	-25°C to -15°C	Thaw at room temperature. Invert 10 times to mix.
XC2	-25°C to -15°C	Thaw at room temperature. Invert 10 times to mix.
XC3	Room temperature	Thaw at room temperature. Invert 10 times to mix.
XC4	Room temperature	Thaw at room temperature. Invert 10 times to mix.

Procedure

Wash BeadChips

- 1 Attach the wire handle and submerge the wash rack in Wash 1 containing 200 ml PB1.



NOTE

Replace PB1 in Wash 1 after every 12 BeadChips.



2 Remove the hybridization chamber inserts from the hybridization chambers.

3 Remove the BeadChips from the hybridization inserts.

4 Remove the cover seals from the BeadChips.

Using powder-free gloved hands, hold the BeadChip securely and by the edges in one hand. Remove the entire seal in a single, continuous motion. Do not touch exposed arrays.

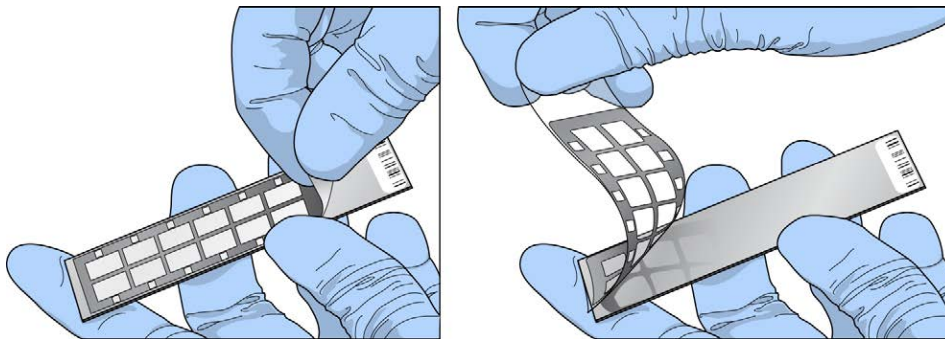

5 Immediately and carefully slide each BeadChip into the wash rack in Wash 1, making sure that the BeadChip is submerged in PB1 a maximum of 8 BeadChips)..

6 Repeat steps 4–5 until all BeadChips are transferred to the submerged wash rack in Wash 1.



- 7 Move the wash rack up and down for 1 minute, breaking the surface of the PB1 with gentle, slow agitation.
- 8 Move the wash rack to Wash 2 containing clean PB1, making sure that the BeadChips are submerged.
- 9 Move the wash rack up and down for 1 minute, breaking the surface of the PB1 with gentle, slow agitation.
- 10 Remove the BeadChips from the wash rack and inspect them for remaining residue.
If you see residue, submerge the BeadChip in PB1 and carefully use a pipette tip to remove the remaining residue.

Assemble Flow-Through Chambers

- 1 Confirm that you are using the correct Infinium glass back plates and spacers before proceeding.

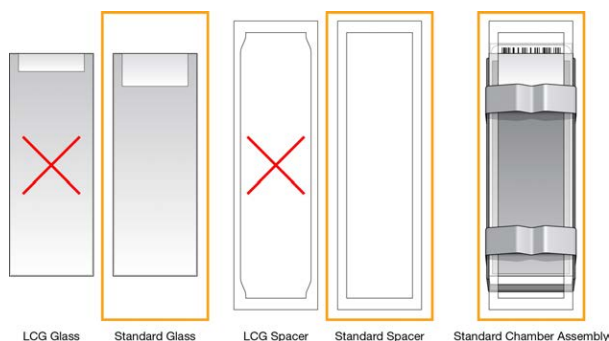

- 2 Fill the BeadChip alignment fixture with 150 ml PB1 for up to 8 BeadChips.
- 3 For each BeadChip, place one black frame into the BeadChip alignment fixture.
For example, if you are processing four BeadChips, place four black frames into the fixture.

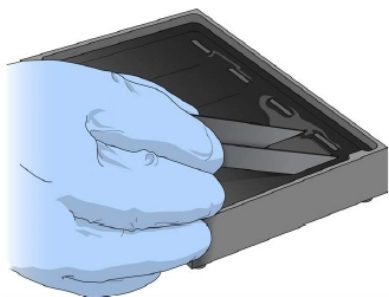

- 4 Place each BeadChip into a black frame, aligning the barcode with the alignment fixture ridges. Fully submerge each BeadChip.



- 5 Place a **clear** spacer onto the top of each BeadChip. Use the alignment fixture grooves to guide the spacers into position.
The white spacers are not a substitute for the clear spacers.

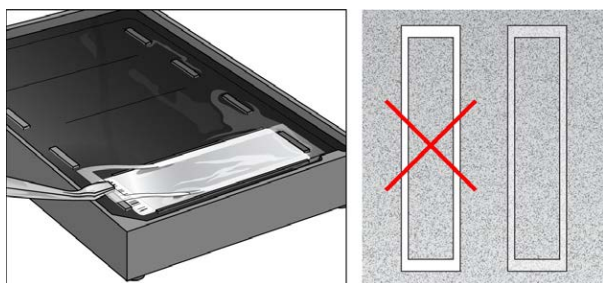

- 6 Place the alignment bar onto the alignment fixture. Fit the groove on the alignment bar over the tab on the alignment fixture.

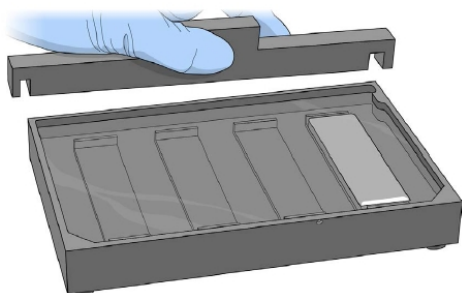

- 7 Place a clean glass back plate on top of each clear spacer. Position the plate reservoir at the barcode end of the BeadChip, facing inward to create a reservoir against the BeadChip surface.

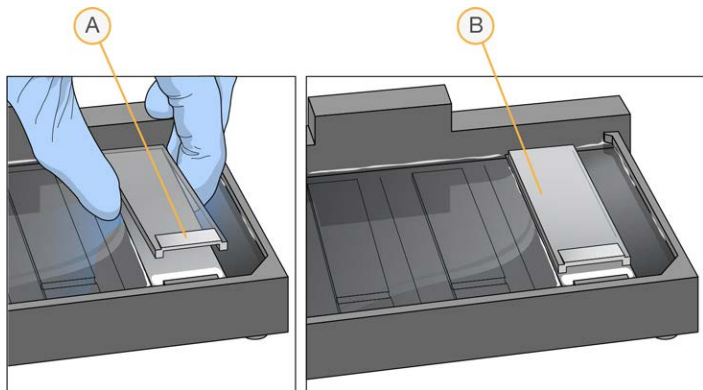

- A Reservoir at barcode end of glass back plate
- B Glass back plate in position

- 8 Secure each flow-through chamber assembly with metal clamps as follows.
 - a Using one finger, gently push the glass back plate against the alignment bar.
 - b Place a metal clamp around the flow-through chamber 5 mm from the top edge.
 - c Place a second metal clamp around the flow-through chamber at the barcode end, 5 mm from the bottom of the reagent reservoir.

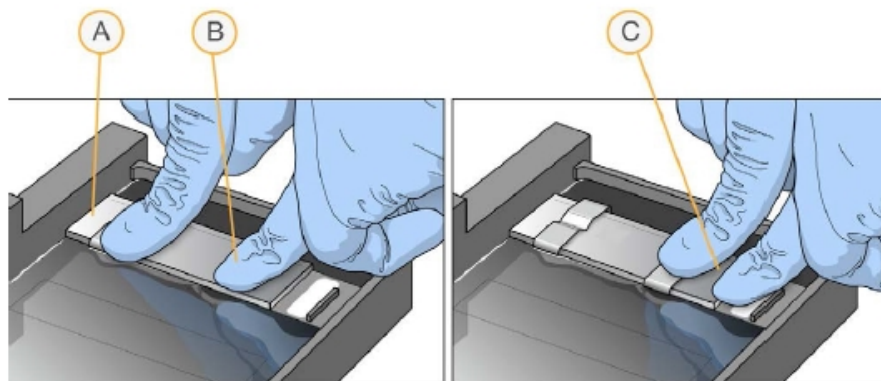

- A One stripe is visible between the first clamp and the alignment bar.
- B Glass back plate pressed against alignment bar.
- C Stripes are not visible between the second clamp and the barcode.

- 9 Remove the assembled flow-through chamber from the alignment fixture.
- 10 Starting at the nonbarcode end, trim the spacers from each end of the assembly using scissors.

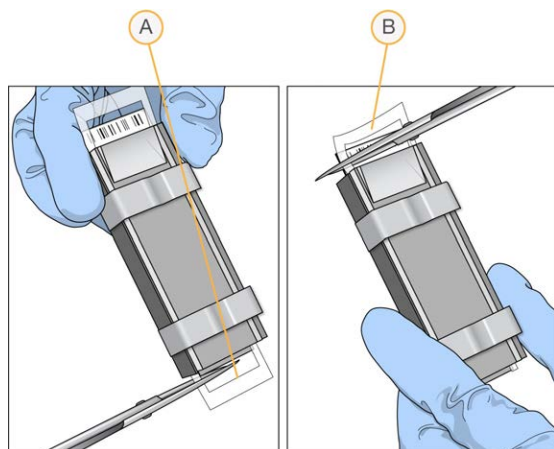

- A Trimming the spacer at the nonbarcode end.
- B Trimming the spacer at the barcode end.

- 11 Leave assembled flow-through chambers on the lab bench in a horizontal position until ready to load onto chamber rack in the *Extend and Stain BeadChips* step.
 - ▶ Do not place on absorbent paper.
 - ▶ Do not place in the chamber rack until instructed to do so.
- 12 Wash the hybridization chamber reservoirs with DI H₂O.
Immediate and thorough washing ensures complete removal of PB1 from the wells.

Extend and Stain BeadChips

This step washes unhybridized and nonspecifically hybridized DNA samples from the BeadChips, adds labeled nucleotides to extend primers hybridized to the sample, and stains the primers. After the flow-through chambers are disassembled, the BeadChips are coated for protection.

Consumables

- ▶ 70 % EtOH (as needed)
- ▶ 95% formamide/1 mM EDTA (15 ml for up to 8 BeadChips, 17 ml for 16, 25 ml for 24)
- ▶ Alconox Powder Detergent (as needed)
- ▶ ATM (2 tubes per 8 BeadChips)
- ▶ PB1 (310 ml for up to 8 BeadChips, 285 ml for 24)
- ▶ RA1 (10 ml for up to 8 BeadChips, 20 ml for 16, 30 ml for 24)
- ▶ STM (2 tubes per 8 BeadChips)
- ▶ TEM (2 tubes per 8 BeadChips)
- ▶ XC1 (2 tubes per 8 BeadChips)
- ▶ XC2 (2 tubes per 8 BeadChips)
- ▶ XC3 (50 ml for up to 8 BeadChips, 100 ml for 16, 150 ml for 24)
- ▶ XC4 (310 ml for up to 8 BeadChips, 285 ml for 24)

About Reagents

- ▶ Make sure that the label of each STM tube indicates the same stain temperature.
- ▶ Decant only the necessary volume of reagent.
- ▶ Use fresh RA1 for each step that requires it. Properly stored RA1 that has not been dispensed for the previous resuspension step or this extend and stain step is considered fresh.
- ▶ RA1 might form visible precipitate or crystals. Before each use, hold in front of a light and inspect. Invert several times to redissolve the solution as needed.
- ▶ The XC4 coat is slippery and makes the BeadChips difficult to hold. Self-locking tweezers grip the BeadChip firmly and help prevent damage.



WARNING

This protocol uses an aliphatic amide that is a probable reproductive toxin. Personal injury can occur through inhalation, ingestion, skin contact, and eye contact. For more information, consult the material data safety sheet for this assay at www.illumina.com/sds. Dispose of containers and any unused contents in accordance with the governmental safety standards for your region.

Preparation

- 1 Prepare the following consumable:

Item	Storage	Instructions
RA1	-25°C to -15°C	Thaw at room temperature.

- 2 Place tubes in rack in order of use. Dispense all bottled reagents into disposable reservoirs as they are needed.

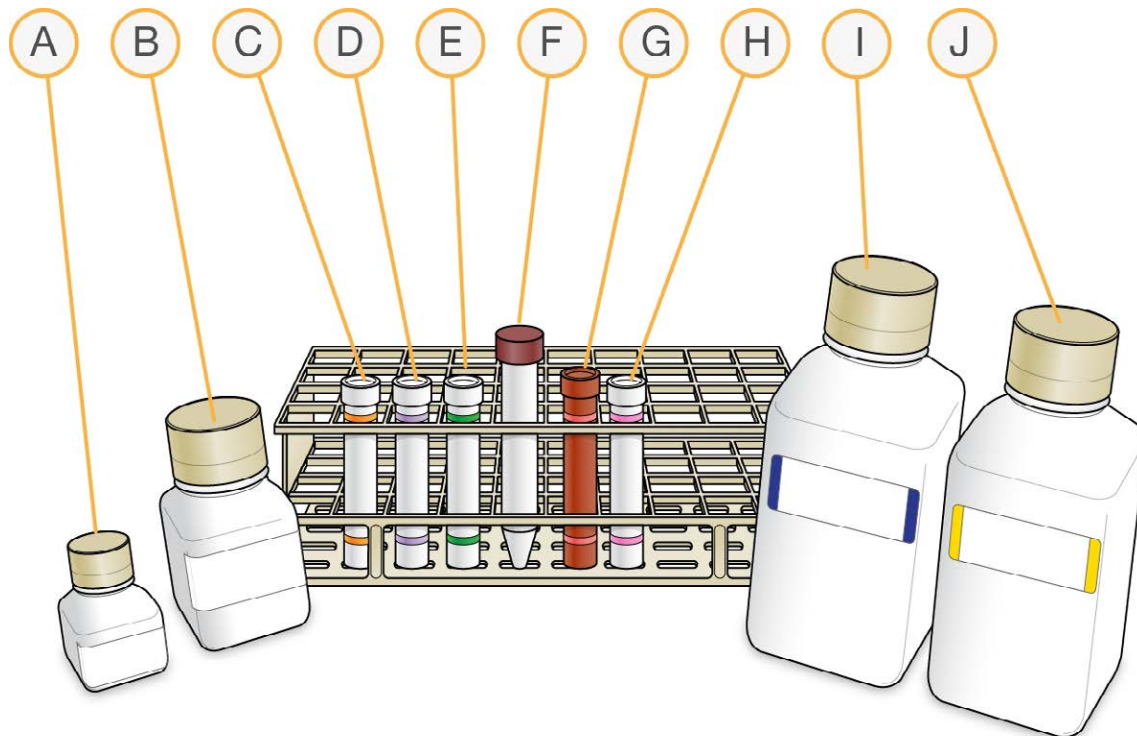

- A RA1
- B XC3
- C XC1
- D XC2
- E TEM
- F 95% Formamide / 1 mM EDTA
- G STM
- H ATM
- I PB1
- J XC4

Procedure

Set Up the Chamber Rack

- 1 Make sure that the water circulator is filled to the appropriate level. See the *VWR Operator Manual*, VWR part # 110-229.
- 2 Turn on the water circulator. Set it to a temperature that brings the Chamber Rack to 44°C at equilibrium. This temperature can vary depending on facility ambient conditions.

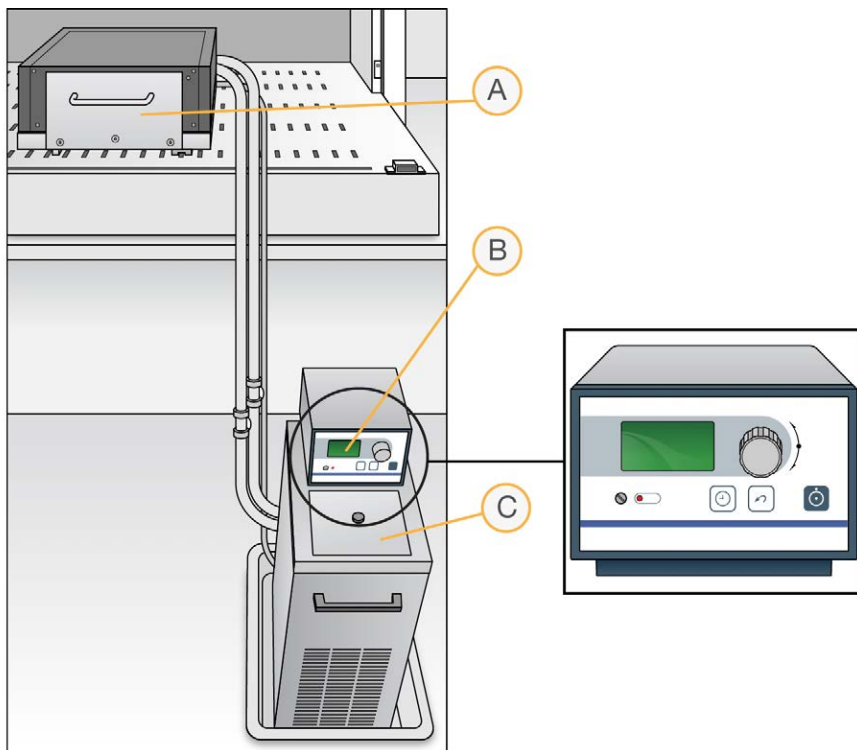

- A Chamber rack
- B Water circulator with programmable temperature controls
- C Reservoir cover

- 3 Confirm the actual temperature using the chamber rack temperature probe.
The temperature displayed on the water circulator screen can differ from the chamber rack temperature.
- 4 Remove bubbles trapped in the chamber rack.
 - a Separate the heat exchanger from the reagent pan.
 - b Lift the heat exchanger upright and away from you with the tubing at the bottom, and turn 90° counter clockwise.
 - c Return the heat exchanger to a horizontal position.
 - d Repeat steps b and c 3 times for a total of 4 rotations or until all bubbles are removed.
 - e Using Kimwipes dampened with laboratory-grade water, clean all surfaces between the heat exchanger and reagent pan. Discard Kimwipes with formamide waste.
 - f Place the Te-Flow back on the reagent pan. Using the two guide pins in the reagent pan, make sure that the Te-Flow is flush.
- 5 Using the Illumina temperature probe, test at least three locations on the chamber rack.
 - a For accurate measurements, make sure that the temperature probe touches the base of the chamber rack.
 - b Make sure that all locations are at 44°C ± 0.5°C.
 - c If the temperature is not within ± 0.5°C, adjust the water circulator control knob to reach 44°C ± 0.5°C.
 - d Do not leave the temperature probe in the first three rows of the chamber rack. Reserve these rows for BeadChips.

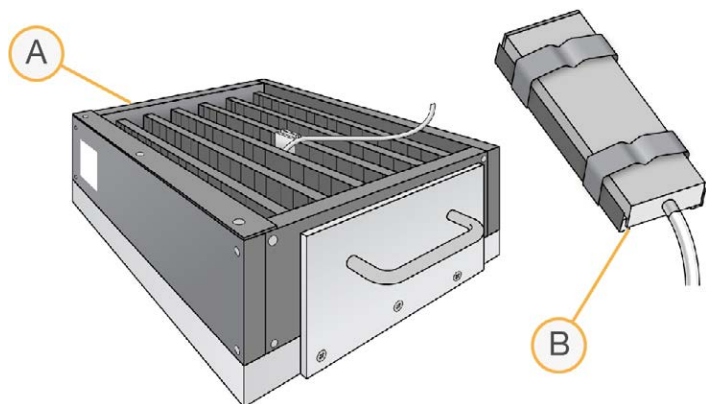

- A Chamber rack with temperature probe
- B Temperature probe

Single-Base Extension and Stain

This step uses a robot to process the BeadChips.



CAUTION

The following steps must be performed without interruption.

- 1 At the robot PC, select **XStain Tasks | XStain HD BeadChip**.
- 2 If imaging immediately after staining, turn on the scanner to allow the lasers to stabilize.
- 3 Place reservoirs on the robot deck according to the deck map, and add reagents to reservoirs as follows:

Reagent	# BeadChips	Volume
95% formamide/1 mM EDTA	1–8	15 ml
	9–16	17 ml
	17–24	25 ml
RA1	1–8	10 ml
	9–16	20 ml
	17–24	30 ml
XC3	1–8	50 ml
	9–16	100 ml
	17–24	150 ml

- 4 Invert the XC1, XC2, TEM, STM, and ATM tubes to mix. Remove the caps, and place on the robot deck according to the deck map.

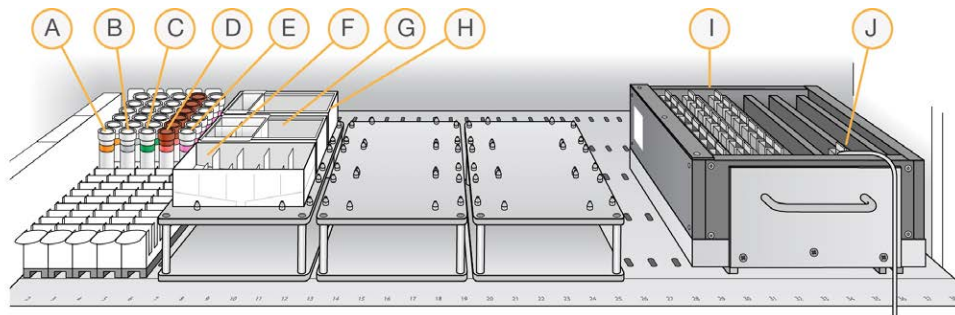

- A XC1 Tubes
- B XC2 Tubes
- C TEM Tubes
- D STM Tubes
- E ATM Tubes
- F XC3 in Full Reservoir
- G RA1 in Half Reservoir
- H 95% Formamide/1 mM EDTA in Quarter Reservoir
- I 24 BeadChips in Chamber Rack
- J Temperature Probe

- 5 In the Basic Run Parameters pane, enter the number of BeadChips.
- 6 Select **Run**.
- 7 **[Non-Illumina LIMS]** When prompted, enter the stain temperature listed on the STM tube. Do not load the BeadChips yet.
- 8 When the chamber rack reaches 44°C, place the flow-through chambers into the chamber rack, according to the robot deck map.



CAUTION

Start the robot immediately to prevent BeadChips from drying.

- 9 At the robot PC, select **OK**.
- 10 When the robot finishes, remove the flow-through chambers from the chamber rack, and place them horizontally on the lab bench at room temperature.

Wash and Coat BeadChips

- 1 Gather the following equipment:
 - ▶ Kimwipes, large
 - ▶ Staining rack
 - ▶ Self-locking tweezers
 - ▶ Tube rack
 - ▶ Vacuum desiccator
 - ▶ Vacuum hose
 - ▶ Wash dishes (2)
- 2 During the procedure, prevent dust or lint from entering the wash dishes.
 - ▶ Clean wash dishes with low-pressure air before use.
 - ▶ Cover wash dishes with wash dish covers when not in use.

- 3 Wash the tube racks and wash dishes thoroughly after each use.
 - ▶ Rinse with deionized water.
 - ▶ Dry racks and wash dishes upside down on a wash rack.
- 4 Place a clean tube rack on top of several layers of Kimwipes or an absorbent pad. After the staining rack containing BeadChips is removed from the XC4 wash dish, it is placed on this rack.
- 5 Prepare another clean tube rack that fits the internal dimensions of vacuum desiccator for removal of the BeadChips. Allow one rack per eight BeadChips. Kimwipes are not needed under this tube rack.
- 6 Set up two top-loading wash dishes labeled PB1 and XC4.
- 7 To indicate fill volume of each wash dish:
 - a Add 310 ml water.
 - b Mark the water level on the side.
 - c Empty the water.

Indicating fill volume before adding reagents allows reagents to be added directly from the bottles, minimizing contamination.

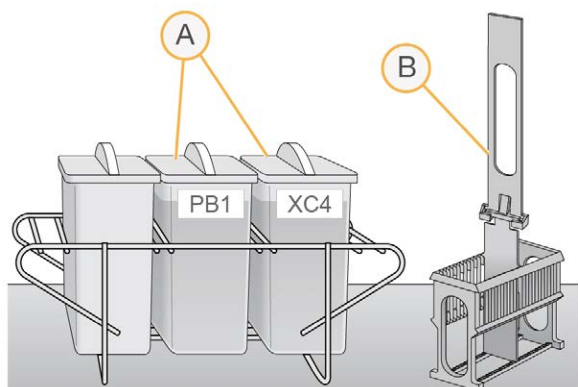

- A Labeled and filled wash dishes
- B Staining rack

- 8 Add 310 ml PB1 to the PB1 wash dish.
- 9 Submerge the staining rack in the wash dish so that the locking arms and tab **face you**. This orientation ensures that you can safely remove the BeadChips.

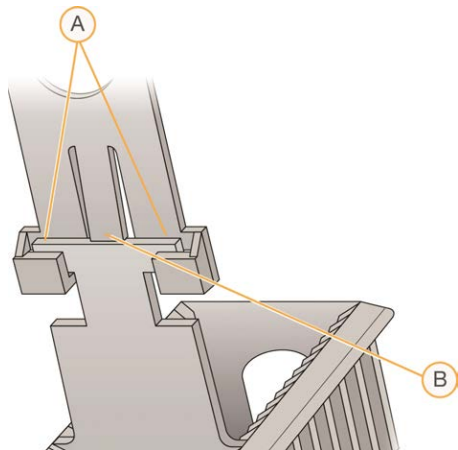

- A Locking arms
- B Tab

- 10 Leave the staining rack in the wash dish for later use (carrying the BeadChips after disassembling the flow-through chambers).
- 11 **Using the dismantling tool**, remove the two metal clamps from a flow-through chamber. The dismantling tool prevents chipping the glass back plates.

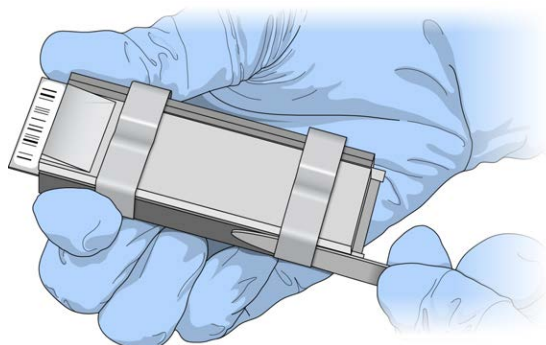

- 12 Lift the glass back plate straight up to remove. Set aside for cleaning after finishing this procedure. Sliding the glass along the BeadChip can damage the BeadChip.
- 13 Remove the spacer, avoiding contact with the BeadChip stripes.
- 14 Remove the BeadChip from the black frame. Handle the BeadChip only by the barcode end or edges.
- 15 Repeat steps 11–14 to disassemble each flow-through chamber one at a time.
- 16 Place the BeadChips into the submerged staining rack. Make sure that the BeadChip barcodes face **away** from you and the locking arms face **toward** you.



CAUTION

Submerge each BeadChip as quickly as possible to prevent drying.

- 17 If necessary to seat a BeadChip, briefly lift the staining rack from the wash dish and seat the BeadChip.
- 18 Make sure that the BeadChips are submerged.
- 19 Slowly move the staining rack up and down 10 times, breaking the PB1 surface. If the tops of the BeadChips touch, gently wiggle the staining rack to separate the slides.

Free circulation of PB1 between BeadChips is important.

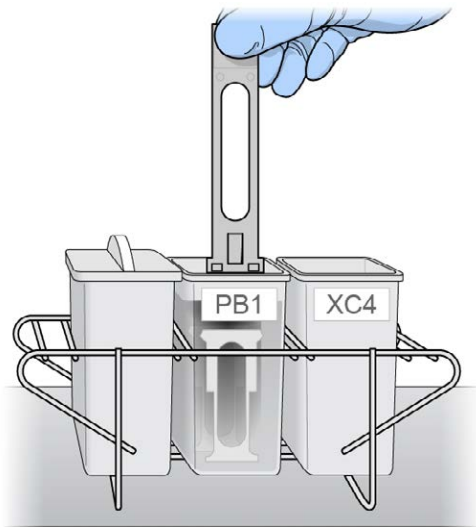

- 20 Soak for 5 minutes.
- 21 Vigorously shake the XC4 bottle to resuspend completely. If necessary, vortex until dissolved.
- 22 Add 310 ml XC4 to the XC4 wash dish.
 - ▶ Cover to prevent lint or dust from entering.
 - ▶ Do not let sit for more than 10 minutes.
- 23 Transfer the staining rack from the PB1 wash dish to the XC4 wash dish.

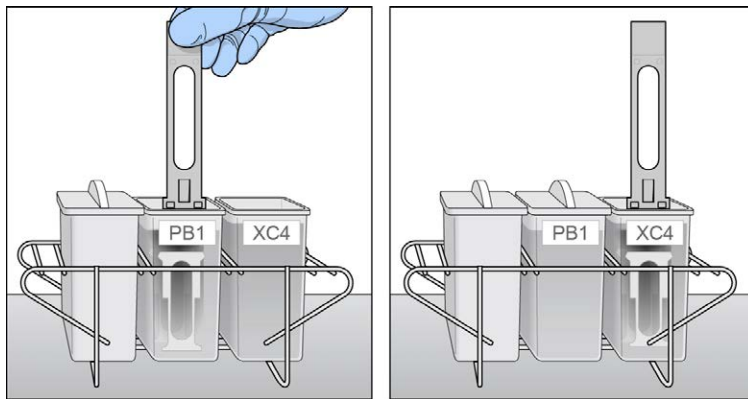

- 24 Slowly lift the staining rack up and down 10 times, breaking the XC4 surface. If the tops of the BeadChips touch, gently wiggle the staining rack to separate the slides.
- 25 Soak for 5 minutes.
- 26 Remove the staining rack in one quick motion and place it onto the prepared tube rack.

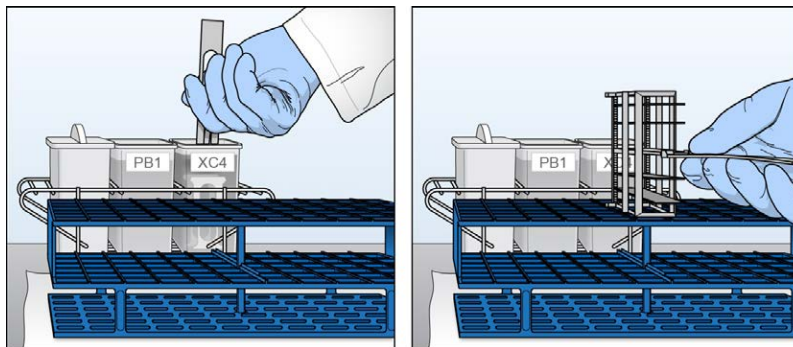

27 Make sure that the staining rack is in the center of the tube rack to ensure uniform coating. Avoid the raised edges.

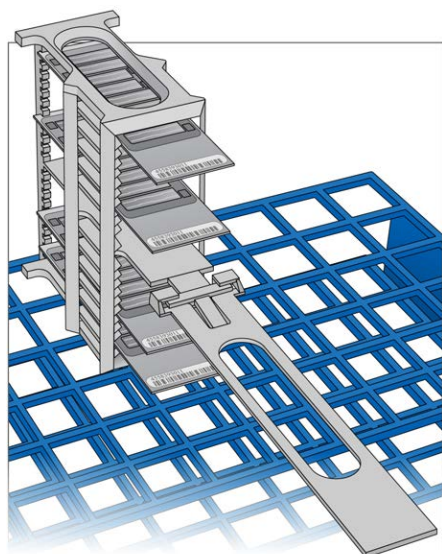

28 **[Optional]** Remove the staining rack handle to facilitate BeadChip removal:

- a Holding the top of the staining rack in position, grasp the handle between your thumb and forefinger.
- b Push up the tab with your thumb and push the handle away from you, unlocking the handle.
- c Pull up the handle and remove.

29 For each BeadChip, working top to bottom:

- a Holding the staining rack handle (if present), use self-locking tweezers to grip the BeadChip by the barcode end.
- b Place the BeadChip onto a tube rack with the barcode facing up and toward you. Do not place on the bottom rack or allow BeadChips to rest on the tube rack edge or touch each other.

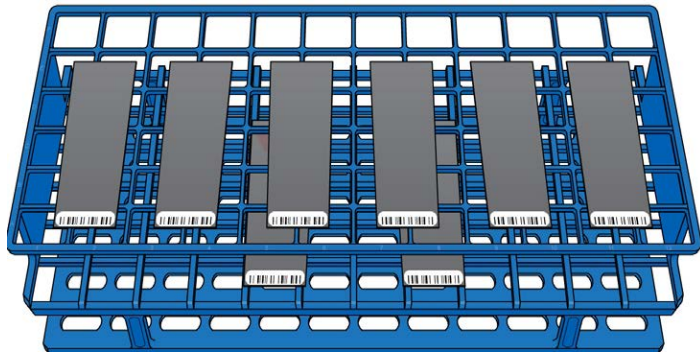

Proper BeadChip placement prevents wicking, uneven drying, and pooled dye protectant.

- 30 Place the tube rack into the vacuum desiccator.
Each desiccator can hold one tube rack (eight BeadChips).
- 31 Make sure that the vacuum desiccator valve is seated tightly and securely, and remove the red plug from the three-way valve.
- 32 Gently lift the vacuum desiccator lid to ensure proper sealing. Make sure that the lid does not lift off the desiccator base.
- 33 Dry the BeadChips in the vacuum desiccator for 50–55 minutes at 675 mm Hg (0.9 bar).
Drying times can vary according to room temperature and humidity.
- 34 Release the vacuum by turning the handle slowly.



WARNING

Make sure that air enters the desiccator very slowly to avoid disturbing the contents. Improper use of the vacuum desiccator can result in damage to the BeadChips, especially if you remove the valve plug while a vacuum is applied. For detailed vacuum desiccator instructions, see the documentation included with the desiccator.

- 35 Return the desiccator to storage. Store with the red valve plug in the three-way valve of the desiccator to prevent dust and lint from accumulating in the valve port.
- 36 Touch the edges of the BeadChips (**do not touch arrays**) to make sure etched, barcoded sides are dry.
- 37 Clean the back of each BeadChip using a Kimwipe sprayed with 70% EtOH:
 - a Hold the BeadChip at a downward angle to prevent excess EtOH from dripping onto the stripes.
 - b Without touching the stripes, wipe the underside of the BeadChip until XC4 is removed (5–6 times).
- 38 Clean the glass back plates.
For instructions, see the *Infinium Lab Setup and Procedures Guide* (document #11322460).

SAFE STOPPING POINT

Store the BeadChips in the Illumina BeadChip Slide Storage Box at room temperature. Scan within 72 hours.

Image BeadChip

Follow the instructions in the System Guide for your instrument to scan your BeadChips.

Use the **Infinium HD** scan setting for your BeadChip.

Illumina GenomeStudio

The Illumina GenomeStudio Genotyping Module, included with your Illumina Infinium Assay system, is an application for extracting genotyping data from intensity data files (*.idat files) collected from your Illumina scanning instrument.

For feature descriptions and instructions on using the GenomeStudio platform to visualize and analyze genotyping data, see the *GenomeStudio Framework User Guide* and the *GenomeStudio User Guide or online help*.

Technical Assistance

For technical assistance, contact Illumina Technical Support.

Website: www.illumina.com
Email: techsupport@illumina.com

Illumina Customer Support Telephone Numbers

Region	Toll Free	Regional
North America	+1.800.809.4566	
Australia	+1.800.775.688	
Austria	+43 800006249	+43 19286540
Belgium	+32 80077160	+32 34002973
China	400.066.5835	
Denmark	+45 80820183	+45 89871156
Finland	+358 800918363	+358 974790110
France	+33 805102193	+33 170770446
Germany	+49 8001014940	+49 8938035677
Hong Kong	800960230	
Ireland	+353 1800936608	+353 016950506
Italy	+39 800985513	+39 236003759
Japan	0800.111.5011	
Netherlands	+31 8000222493	+31 207132960
New Zealand	0800.451.650	
Norway	+47 800 16836	+47 21939693
Singapore	+1.800.579.2745	
South Korea	+82 80 234 5300	
Spain	+34 911899417	+34 800300143
Sweden	+46 850619671	+46 200883979
Switzerland	+41 565800000	+41 800200442
Taiwan	00806651752	
United Kingdom	+44 8000126019	+44 2073057197
Other countries	+44.1799.534000	

Safety data sheets (SDSs)—Available on the Illumina website at support.illumina.com/sds.html.

Product documentation—Available for download from support.illumina.com.



Illumina

5200 Illumina Way

San Diego, California 92122 U.S.A.

+1.800.809.ILMN (4566)

+1.858.202.4566 (outside North America)

techsupport@illumina.com

www.illumina.com

For Research Use Only. Not for use in diagnostic procedures.

© 2019 Illumina, Inc. All rights reserved.

illumina[®]